

bott cubio

The workshop equipment system



Drawer cabinets
Workbenches

Workshop
equipment



Custom solutions for
maintenance and
production

	page
F	
bott - an introduction	4 – 5
C	
Quality standards	6 – 7
Your idea - Our planning	8 – 9
E	
Care Line - The hygiene concept	10 - 11
 cubio - The workshop equipment system	12 – 19
Drawer cabinets	20 – 67
F	
Drawer dividers	68 – 91
Cupboards	92 – 115
C	
Accessories for drawer cabinets and cupboards	116 – 127
Storage benches	128 – 141
O	
Framework benches	142 – 155
Accessories for storage and framework benches	156 – 175
U	
CNC storage cupboards	176 – 187
avero - The workstation system	188 – 215
Team workstations and Workstation design	216 – 225
bottBoxes and Euroboxes	226 – 237
Cases	238 – 281
perfo - The organisation system	282 – 329

Get



bott cubio – a robust professional storage system, featuring workbenches, drawer cabinets, cupboards and maintenance trolleys. Available in a wide range of sizes, with a choice of mobile and static options, cubio promotes organisation and efficiency in the workshop.

Organised



A unique feature of the systainer³ storage case is that its integrated storage rails make it compatible with both cubio workshop and bott vario3 in-vehicle storage equipment. The most important tools and equipment are always to hand, neatly organised and easily accessible.

bott - an introduction

For almost 90 years we have offered our customers all over the world a wide-ranging product portfolio, the highest-possible quality and a first-class service. In particular, the high level of customer satisfaction ensures bott's continued growth.

Innovation has the highest priority at bott. With us you'll invest in a modern, long-term solution and therefore in lasting success.



Founded:	1930
Turnover:	245 million euros (2024)
No. of employees:	1500 (2024)

95 years



Experience makes the difference

As a long-term global partner, we supply consistently high-quality products, services and solutions that offer excellent value for money. The result is an exceptional customer experience. We deliver intelligent workplace and mobility solutions for tradespeople and companies who are targeting greater operational efficiency or simply a better use of space.

To this end, we combine our innovative, high-value products and services with new technologies to create integrated, market-leading solutions that are based on thorough knowledge of customer needs. In a fast-changing world, we must be agile and flexible. In a

dynamic environment, we are constantly learning, working together on an international level and coming up with new products. This enables our employees and other stakeholders to contribute to our joint success and to profit from it themselves.

Quality standards

Certified in accordance
with DIN EN ISO 9001

Products with the GS label for TÜV-tested
safety (German safety standard)

Certified





Certified quality

High stability, sturdiness and durability:

These are our main principles for production of bott products. When we deliver the best quality possible, we guarantee that your investment will be worthwhile. We always validate our production and logistics processes through internal and external guidelines, inspections and audits.

Our quality principles

- Certified in accordance with DIN EN ISO 9001
- Certified environmental management in accordance with ISO 14001
- Products have GS mark for TÜV-tested safety

Your idea - our planning

Uniform system dimensions

Experience-based solutions

Stability and durability



Individual planning, to suit your needs

cupio offers you numerous variations and possibilities of combining individual components. We plan your workshop equipment individually and to match your needs.

If you should require extensions for or adaptations to individual modules over time, this is no problem. Thanks to the modular design, the components can easily be modified or supplemented.

Different drawer dividing options ensure structure and order. Labels provide an overview on and in the drawers. Your tools and equipment are always to hand, neatly organised and easily accessible

bott Care Station

bott Care Station

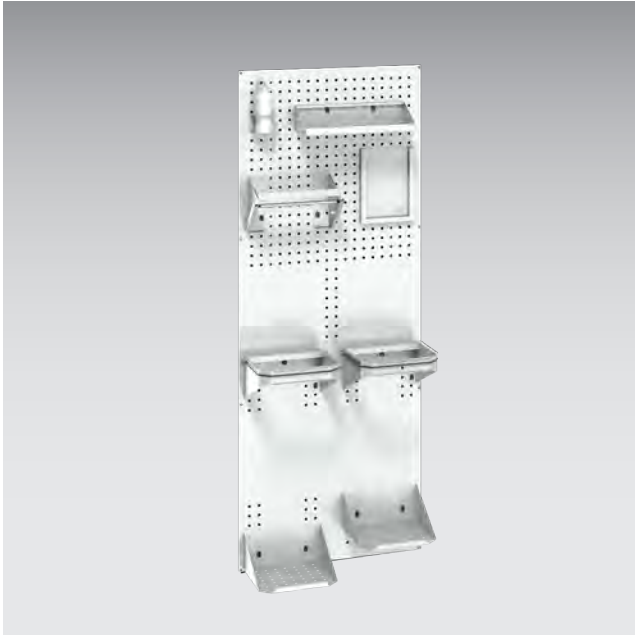

- Disinfection station for mounting to the wall and other suitable elements
- For easy access to cleaning or disinfectant materials
- 1x perfo Care Station base plate (RAL 7035)
- 1x perfo paper roll holder with tear-off edge
- 1x perfo document holder DIN A4
- 1x perfo holder for single-use gloves
- 1x Scrubs box with holder
- 2x perfo rubbish bag holders without lid
- 2x perfo rubbish bag holders-support shelf

Dimensions W x D x H [mm]

735 x 340 x 1981

Order ref.

14030230.16

Care Line - The hygiene concept



Options



10 for perfo hooks, holders and hygiene items see page 299

bott Care Trolley

bott Care Trolley



- 2 swivel & brake castors and 2 fixed castors
- 1 pull handle
- perfo panels, can be mounted vertically or at an angle
- Base shelf as additional storage space suitable for tool cases or boxes
- Colour of base frame: light grey (RAL 7035)

Dimensions W x D x H [mm]	1006 x 648 x 1585
Order ref.	14026025.**



	.11		.24	.19
Housing: RAL 7035 – light grey	Top, base and fronts: Details on page 15 RAL 5010 – gentian blue RAL 7035 – light grey RAL 3004 – crimson red RAL 7016 – anthracite grey			

cubio

Precise functions

High load capacities

Modular system



The Workshop Equipment

We organise your storage space perfectly, allowing you to be fully prepared for efficient working. We take a detailed look at your individual needs and design your workshop equipment to suit your particular workflows.

With cubio drawer cabinets, workbenches and cupboards, we are offering you unique modular workshop equipment which can be configured exactly as you would like it. Maximum reliability, functionality and ease of use make cubio the ideal solution for all your different tasks.

The attractive and cohesive cubio design with its standard system dimensions gives your workshop equipment a uniform look, regardless of the wide variety of applications.

Range of services



Uniform system dimensions

- The same dimensions for all cubio product groups: Drawer cabinets, cupboards and workbenches
- For easy and flexible planning
- Allows for combinations with dimensional accuracy

The same system components

- Drawer bodies, shelves and sliding shelves are identical in all cubio product groups
- Cubio drawer organisation systems can be exchanged among cubio product groups

Colour scheme



The bott cubio colour options for the top, base and front consist of the four colours listed below. The housing is always coloured light-grey. All order references in the catalogue marked **. ** must be ordered with one of the colour codes listed.

When ordering, depending on your choice of colour, simply replace the marker **. ** by one of these colour codes, e.g. 40020011.11V for a product in gentian blue.

Some cubio drawer cabinets and cupboards with doors are available to order with light grey ESD conductive surfaces. Your bott representative will be more than happy to discuss ESD protection zones and ESD workstations with you.



3

Year warranty*

* bott grants the ultimate purchaser (end user), in addition to the statutory warranty claims, a 3-year product warranty according to bott warranty conditions. bott guarantees, for a period of 3 years from date of delivery, that the supplied products will be free from defects in terms of materials and workmanship. Warranty does not cover electronic components and modules.

The colour panels shown may not match the original colours for printing-related reasons.



Range of services



Workbench attachments

- For mounting on top of workbench
- Rear panel with perforated panels and louvred panels for provision of materials and tools
- Creation of ergonomic work places with the help of modular mounting frames for integration of multiple average accessories

Internal drawers and sliding shelves

- For individual kitting of cupboards
- All drawers and sliding shelves are supplied with full extension slides and 40 mm overextension
- Heavy duty slides with 200 kg load capacity
- Standard-duty drawer slides with 75 kg load capacity



Schubladen-Einzelsicherung

- for mobile cabinets with integrated individual drawer lock and handle

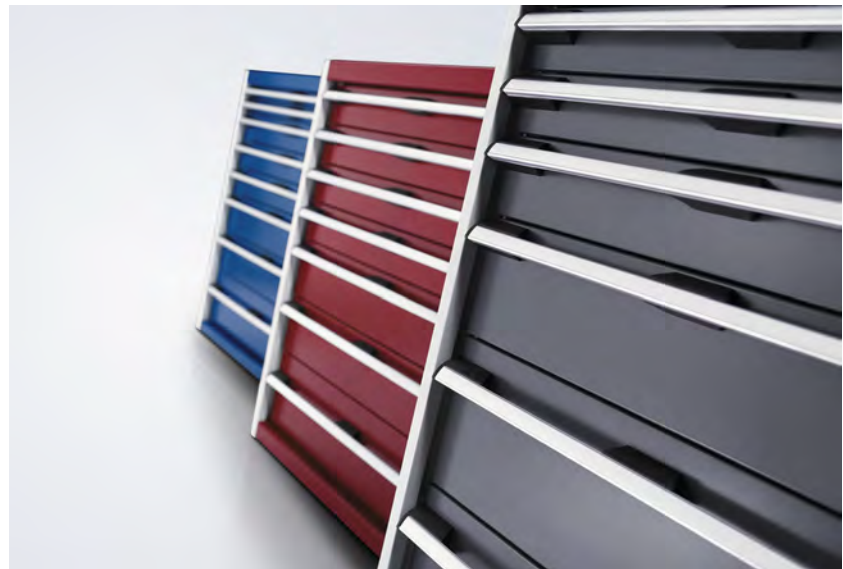

Continuous design and colour concept

- Consistent design thanks to its clear lines and modern colour scheme
- Uniform appearance throughout the entire operation
- Special colours and CI-certified paint available upon request

Range of services



Service ducts

- For customised combinations of switch and fuse modules, socket modules, compressed air and network modules in standard module widths
- Universal fixing kits for mounting on a worktop or to rear frames

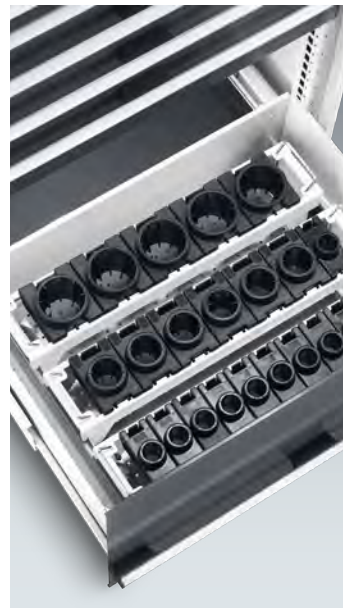

Solutions for CNC Tools

- Safe and clear storage of valuable tools
- Tool inserts for attachments of all standard options
- Mobile systems for rapid provisioning

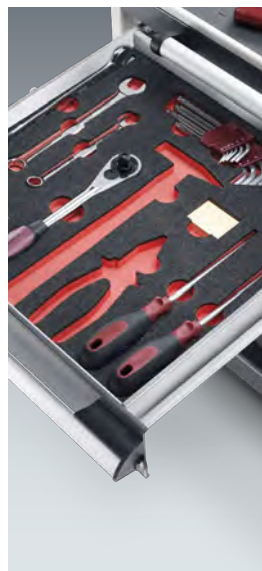

Same drawer divider options

- Identical organisation components for all drawers in the cubio product groups
- Versatile drawer division with trough blocks, dividers and cross dividers, small parts storage boxes and foam inlays
- Extensive labelling options



perfo



- Identical organisation components for all drawers in the cubio product groups
- Versatile drawer division with trough blocks, dividers and cross dividers, small parts storage boxes and foam inlays
- Extensive labelling options

Drawer cabinets



Drawer cabinets



Drawers

- All drawers supplied with full extension slides and 40 mm overextension
- Heavy duty slides with 200 kg load capacity
- Standard-duty drawer slides with 75 kg load capacity
- Ergonomic handle with access from above or below; mobile cabinets come with drawer trigger locks and a trolley handle
- Can be labelled using Microsoft® Word® document template.



Drawer dividers

- Suitable for use in all drawers in the cubio product range
- Adjustable metal dividers, plastic troughs and boxes, inlay mats and many other practical solutions
- Can be labelled using Microsoft® Word® document template.



Housing

- Load capacity up to 1.5 tonnes
- Intelligent drawer blocking mechanism prevents more than one drawer opening at once
- Mechanical cabinet lock with 5-pin interchangeable cylinder for optional locking system design



Accessories

- 4-sided raised lip with anti-slip mat
- Shelves
- Sliding shelf
- Basic plinths

Width 525 mm

Height 250 mm - standard duty slide 75 kg



Depth [mm]	525	650
Version	Standard duty	Standard duty
Quantity of drawers/doors	1	1
Front height [mm]	1x150	1x150
Order ref.	40010001.**V	40018001.**V

Height 400 mm - standard duty slide 75 kg



Depth [mm]	525	525	650	650
Version	Standard duty	Standard duty	Standard duty	Standard duty
Quantity of drawers/doors	2	3	2	3
Front height [mm]	2x150	2x75, 1x150	2x150	2x75, 1x150
Order ref.	40010005.**V	40010106.**V	40018005.**V	40018127.**V

Height 600 mm - standard duty slide 75 kg



Depth [mm]	525	650
Version	Standard duty	Standard duty
Quantity of drawers/doors	4	4
Front height [mm]	2x75, 1x150, 1x200	2x75, 1x150, 1x200
Order ref.	40010112.**V	40018017.**V



Drawer dividers from page 68

Width 525 mm

Height 700 mm - standard duty slide 75 kg



Depth [mm]	525	525	525
Version	Standard duty	Standard duty	Standard duty
Quantity of drawers/doors	2, 1	5	5
Front height [mm]	1x75, 1x100	2x75, 1x100, 1x150, 1x200	3x100, 2x150
Order ref.	40010017.**V	40010115.**V	40010127.**V



Depth [mm]	650	650	650
Version	Standard duty	Standard duty	Standard duty
Quantity of drawers/doors	2, 1	5	5
Front height [mm]	1x75, 1x100	2x75, 1x100, 1x150, 1x200	3x100, 2x150
Order ref.	40018021.**V	40018027.**V	40018138.**V







Height 800 mm - standard duty slide 75 kg



Depth [mm]	525	525	525	525
Version	Standard duty	Standard duty	Standard duty	Standard duty
Quantity of drawers/doors	2, 1	4	5	6
Front height [mm]	1x100, 1x175, 1x400	2x100, 1x200, 1x300	2x100, 2x150, 1x200	2x75, 2x100, 1x150, 1x200
Order ref.	40010023.**V	40010025.**V	40010027.**V	40010117.**V

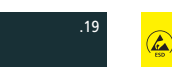

Depth [mm]	650	650	650	650
Version	Standard duty	Standard duty	Standard duty	Standard duty
Quantity of drawers/doors	2, 1	4	5	6
Front height [mm]	1x100, 1x175, 1x400	2x100, 1x200, 1x300	2x100, 2x150, 1x200	2x75, 2x100, 1x150, 1x200
Order ref.	40018031.**V	40018033.**V	40018037.**V	40018039.**V

	 .11	 .16	 .24	 .19	 .20
Housing: RAL 7035 – light grey	Top, base and fronts: Details on page 15 RAL 5010 – gentian blue RAL 7035 – light grey RAL 3004 – crimson red			RAL 7016 – anthracite grey	ESD version available RAL 7035 – light grey

Width 525 mm

Height 900 mm - standard duty slide 75 kg



Depth [mm]	525	525	525	525
Version	Standard duty	Standard duty	Standard duty	Standard duty
Quantity of drawers/doors	3, 1	5	6	7
Front height [mm]	1x100, 1x125, 1x150	3x100, 1x200, 1x300	3x100, 2x150, 1x200	5x100, 2x150
Order ref.	40010033.**V	40010035.**V	40010039.**V	40010041.**V



Depth [mm]	650	650	650	650
Version	Standard duty	Standard duty	Standard duty	Standard duty
Quantity of drawers/doors	3, 1	5	6	7
Front height [mm]	1x100, 1x125, 1x150	3x100, 1x200, 1x300	3x100, 2x150, 1x200	5x100, 2x150
Order ref.	40018043.**V	40018045.**V	40018049.**V	40018051.**V

Height 1000 mm - standard duty slide 75 kg



Depth [mm]	525	525	525	525
Version	Standard duty	Standard duty	Standard duty	Standard duty
Quantity of drawers/doors	4, 1	5	6	7
Front height [mm]	2x100, 1x125, 1x150	2x100, 2x200, 1x300	2x100, 2x150, 2x200	2x75, 2x100, 1x150, 2x200
Order ref.	40010043.**V	40010045.**V	40010047.**V	40010051.**V



Depth [mm]	650	650	650	650
Version	Standard duty	Standard duty	Standard duty	Standard duty
Quantity of drawers/doors	4, 1	5	6	7
Front height [mm]	2x100, 1x125, 1x150	2x100, 2x200, 1x300	2x100, 2x150, 2x200	2x75, 2x100, 1x150, 2x200
Order ref.	40018055.**V	40018057.**V	40018059.**V	40018061.**V



Drawer dividers from page 68

Width 650 mm

Height 250 mm - standard duty slide 75 kg



Depth [mm]	525	650
Version	Standard duty	Standard duty
Quantity of drawers/doors	1	1
Front height [mm]	1x150	1x150
Order ref.	40011035.**V	40019001.**V

Height 400 mm - standard duty slide 75 kg



Depth [mm]	525	525	525
Version	Standard duty	Standard duty	Standard duty
Quantity of drawers/doors	2	3	3
Front height [mm]	2x150	2x75, 1x150	3x100
Order ref.	40011037.**V	40011038.**V	40011068.**V



Depth [mm]	650	650
Version	Standard duty	Standard duty
Quantity of drawers/doors	2	3
Front height [mm]	2x150	2x75, 1x150
Order ref.	40019005.**V	40019146.**V

Width 650 mm

Height 600 mm - standard duty slide 75 kg



Depth [mm]	525	525	650
Version	Standard duty	Standard duty	Standard duty
Quantity of drawers/doors	4	5	4
Front height [mm]	2x75, 1x150, 1x200	2x75, 2x100, 1x150	2x75, 1x150, 1x200
Order ref.	40011040.**V	40011061.**V	40019015.**V

Drawer cabinets



Options

Width 650 mm

Height 700 mm - standard duty slide 75 kg



Depth [mm]	525	525	525	525
Version	Standard duty	Standard duty	Standard duty	Standard duty
Quantity of drawers/doors	2, 1	4	5	5
Front height [mm]	1x75, 1x100	1x100, 2x150, 1x200	2x75, 1x100, 1x150, 1x200	3x100, 2x150
Order ref.	40011041.**V	40011062.**V	40011042.**V	40011043.**V



Depth [mm]	650	650	650
Version	Standard duty	Standard duty	Standard duty
Quantity of drawers/doors	2, 1	5	5
Front height [mm]	1x75, 1x100	2x75, 1x100, 1x150, 1x200	3x100, 2x150
Order ref.	40019021.**V	40019027.**V	40019161.**V



Depth [mm]	750	750	750
Version	Standard duty	Standard duty	Standard duty
Quantity of drawers/doors	2, 1	4	5
Front height [mm]	1x75, 1x100	1x100, 2x150, 1x200	2x75, 1x100, 1x150, 1x200
Order ref.	40027001.**V	40027005.**V	40027007.**V

Width 650 mm

Height 800 mm - standard duty slide 75 kg



Depth [mm]	525	525	525	525
Version	Standard duty	Standard duty	Standard duty	Standard duty
Quantity of drawers/doors	2, 1	4	5	6
Front height [mm]	1x100, 1x175, 1x400	2x100, 1x200, 1x300	2x100, 2x150, 1x200	2x75, 2x100, 1x150, 1x200
Order ref.	40011044.**V	40011045.**V	40011046.**V	40011047.**V



Depth [mm]	650	650	650	650
Version	Standard duty	Standard duty	Standard duty	Standard duty
Quantity of drawers/doors	2, 1	4	5	6
Front height [mm]	1x100, 1x175, 1x400	2x100, 1x200, 1x300	2x100, 2x150, 1x200	2x75, 2x100, 1x150, 1x200
Order ref.	40019031.**V	40019033.**V	40019035.**V	40019039.**V



Depth [mm]	750	750	750
Version	Standard duty	Standard duty	Standard duty
Quantity of drawers/doors	2, 1	5	6
Front height [mm]	1x100, 1x175	2x100, 2x150, 1x200	2x75, 2x100, 1x150, 1x200
Order ref.	40027011.**V	40027015.**V	40027019.**V



Drawer dividers from page 68

Width 650 mm

Height 900 mm - standard duty slide 75 kg



Depth [mm]	525	525	525	525
Version	Standard duty	Standard duty	Standard duty	Standard duty
Quantity of drawers/doors	3, 1	5	6	7
Front height [mm]	1x100, 1x125, 1x150	3x100, 1x200, 1x300	3x100, 2x150, 1x200	5x100, 2x150
Order ref.	40011048.**V	40011049.**V	40011050.**V	40011051.**V



Depth [mm]	650	650	650	650
Version	Standard duty	Standard duty	Standard duty	Standard duty
Quantity of drawers/doors	3, 1	5	6	7
Front height [mm]	1x100, 1x125, 1x150	3x100, 1x200, 1x300	3x100, 2x150, 1x200	5x100, 2x150
Order ref.	40019043.**V	40019045.**V	40019049.**V	40019051.**V



Depth [mm]	750	750	750
Version	Standard duty	Standard duty	Standard duty
Quantity of drawers/doors	3, 1	6	7
Front height [mm]	1x100, 1x125, 1x150	3x100, 2x150, 1x200	5x100, 2x150
Order ref.	40027104.**V	40027088.**V	40027090.**V

Width 650 mm

Height 1000 mm - standard duty slide 75 kg



Depth [mm]	525	525	525	525
Version	Standard duty	Standard duty	Standard duty	Standard duty
Quantity of drawers/doors	4, 1	5	6	7
Front height [mm]	2x100, 1x125, 1x150	2x100, 2x200, 1x300	2x100, 2x150, 2x200	2x75, 2x100, 1x150, 2x200
Order ref.	40011052.**V	40011053.**V	40011054.**V	40011055.**V



Depth [mm]	650	650	650	650
Version	Standard duty	Standard duty	Standard duty	Standard duty
Quantity of drawers/doors	4, 1	5	6	7
Front height [mm]	2x100, 1x125, 1x150	2x100, 2x200, 1x300	2x100, 2x150, 2x200	2x75, 2x100, 1x150, 2x200
Order ref.	40019055.**V	40019057.**V	40019059.**V	40019063.**V



Depth [mm]	750	750	750
Version	Standard duty	Standard duty	Standard duty
Quantity of drawers/doors	4, 1	6	7
Front height [mm]	2x100, 1x125, 1x150	2x100, 2x150, 2x200	2x75, 2x100, 1x150, 2x200
Order ref.	40027023.**V	40027027.**V	40027031.**V



Drawer dividers from page 68

Width 650 mm

Height 1200 mm - standard duty slide 75 kg



Depth [mm]	525	525	525
Version	Standard duty	Standard duty	Standard duty
Quantity of drawers/doors	7	8	10
Front height [mm]	4x100, 2x200, 1x300	2x75, 1x100, 3x150, 2x200	8x100, 2x150
Order ref.	40011063.**V	40011064.**V	40011065.**V



Depth [mm]	650	650	650
Version	Standard duty	Standard duty	Standard duty
Quantity of drawers/doors	7	8	10
Front height [mm]	4x100, 2x200, 1x300	2x75, 1x100, 3x150, 2x200	8x100, 2x150
Order ref.	40019069.**V	40019071.**V	40019075.**V



Depth [mm]	750	750	750
Version	Standard duty	Standard duty	Standard duty
Quantity of drawers/doors	7	8	10
Front height [mm]	4x100, 2x200, 1x300	2x75, 1x100, 3x150, 2x200	8x100, 2x150
Order ref.	40027037.**V	40027039.**V	40027043.**V

Width 650 mm

Height 1600 mm - standard duty slide 75 kg



Depth [mm]	525	525
Version	Standard duty	Standard duty
Quantity of drawers/doors	9	11
Front height [mm]	2x100, 4x150, 2x200, 1x300	4x100, 2x125, 3x150, 2x200
Order ref.	40011066.**V	40011067.**V



Depth [mm]	650	650
Version	Standard duty	Standard duty
Quantity of drawers/doors	9	11
Front height [mm]	2x100, 4x150, 2x200, 1x300	4x100, 2x125, 3x150, 2x200
Order ref.	40019154.**V	40019156.**V



Depth [mm]	750	750
Version	Standard duty	Standard duty
Quantity of drawers/doors	9	11
Front height [mm]	2x100, 4x150, 2x200, 1x300	4x100, 2x125, 3x150, 2x200
Order ref.	40027045.**V	40027047.**V



Drawer dividers from page 68

Width 800 mm

Height 700 mm - standard duty slide 75 kg



Depth [mm]	525	525	525
Version	Standard duty	Standard duty	Standard duty
Quantity of drawers/doors	2, 2	5	5
Front height [mm]	1x75, 1x100	2x75, 1x100, 1x150, 1x200	3x100, 2x150
Order ref.	40012007.**V	40012095.**V	40012116.**V



Depth [mm]	650	650	650
Version	Standard duty	Standard duty	Standard duty
Quantity of drawers/doors	2, 2	5	5
Front height [mm]	1x75, 1x100	2x75, 1x100, 1x150, 1x200	3x100, 2x150
Order ref.	40020011.**V	40020017.**V	40020145.**V



Depth [mm]	750	750	750	750
Version	Standard duty	Standard duty	Standard duty	Standard duty
Quantity of drawers/doors	2, 2	4	5	5
Front height [mm]	1x100, 1x175, 1x400	1x100, 2x150, 1x200	2x75, 1x100, 1x150, 1x200	3x100, 2x150
Order ref.	40028095.**V	40028003.**V	40028005.**V	40028111.**V

Width 800 mm

Height 800 mm - standard duty slide 75 kg



Depth [mm]	525	525	525	525
Version	Standard duty	Standard duty	Standard duty	Standard duty
Quantity of drawers/doors	2, 2	4	5	6
Front height [mm]	1x100, 1x175, 1x400	2x100, 1x200, 1x300	2x100, 2x150, 1x200	2x75, 2x100, 1x150, 1x200
Order ref.	40012013.**V	40012015.**V	40012017.**V	40012097.**V



Depth [mm]	650	650	650	650
Version	Standard duty	Standard duty	Standard duty	Standard duty
Quantity of drawers/doors	2, 2	4	5	6
Front height [mm]	1x100, 1x175	2x100, 1x200, 1x300	2x100, 2x150, 1x200	2x75, 2x100, 1x150, 1x200
Order ref.	40020021.**V	40020023.**V	40020025.**V	40020129.**V



Depth [mm]	750	750	750
Version	Standard duty	Standard duty	Standard duty
Quantity of drawers/doors	2, 2	4	5
Front height [mm]	1x100, 1x175	2x100, 1x200, 1x300	2x100, 2x150, 1x200
Order ref.	40028097.**V	40028009.**V	40028011.**V



Drawer dividers from page 68

Width 800 mm

Height 800 mm - heavy duty slide 200 kg



Depth [mm]	650	650	650
Version	Heavy duty	Heavy duty	Heavy duty
Quantity of drawers/doors	4	5	6
Front height [mm]	2x100, 1x200, 1x300	2x100, 2x150, 1x200	2x75, 2x100, 1x150, 1x200
Order ref.	40020024.**V	40020026.**V	40020130.**V



Depth [mm]	750	750	750	750
Version	Heavy duty	Heavy duty	Heavy duty	Heavy duty
Quantity of drawers/doors	2, 2	4	5	6
Front height [mm]	1x100, 1x175	2x100, 1x200, 1x300	2x100, 2x150, 1x200	2x75, 2x100, 1x150, 1x200
Order ref.	40028098.**V	40028010.**V	40028012.**V	40028088.**V



Housing:

RAL 7035 – light grey

Top, base and fronts: Details on page 15

RAL 5010 – gentian blue

RAL 7035 – light grey

RAL 3004 – crimson red

RAL 7016 – anthracite grey

ESD version available

RAL 7035 – light grey

Width 800 mm

Height 900 mm - standard duty slide 75 kg



Depth [mm]	525	525	525	525
Version	Standard duty	Standard duty	Standard duty	Standard duty
Quantity of drawers/doors	3, 2	5	6	7
Front height [mm]	1x100, 1x125, 1x150	3x100, 1x200, 1x300	3x100, 2x150, 1x200	5x100, 2x150
Order ref.	40012023.**V	40012025.**V	40012087.**V	40012029.**V



Depth [mm]	650	650	650	650
Version	Standard duty	Standard duty	Standard duty	Standard duty
Quantity of drawers/doors	3, 2	5	6	7
Front height [mm]	1x100, 1x125, 1x150	3x100, 1x200, 1x300	3x100, 2x150, 1x200	5x100, 2x150
Order ref.	40020033.**V	40020035.**V	40020120.**V	40020041.**V



Depth [mm]	750	750	750	750
Version	Standard duty	Standard duty	Standard duty	Standard duty
Quantity of drawers/doors	3, 2	5	6	7
Front height [mm]	1x100, 1x125, 1x150	3x100, 1x200, 1x300	3x100, 2x150, 1x200	5x100, 2x150
Order ref.	40028104.**V	40028113.**V	40028115.**V	40028108.**V



Drawer dividers from page 68

Width 800 mm

Height 900 mm - heavy duty slide 200 kg



Depth [mm]	650	650	650
Version	Heavy duty	Heavy duty	Heavy duty
Quantity of drawers/doors	5	6	7
Front height [mm]	3x100, 1x200, 1x300	3x100, 2x150, 1x200	5x100, 2x150
Order ref.	40020036.**V	40020147.**V	40020042.**V



Depth [mm]	750	750	750
Version	Heavy duty	Heavy duty	Heavy duty
Quantity of drawers/doors	5	6	7
Front height [mm]	3x100, 1x200, 1x300	3x100, 2x150, 1x200	5x100, 2x150
Order ref.	40028114.**V	40028116.**V	40028109.**V



Housing:

RAL 7035 – light grey

Top, base and fronts: Details on page 15

RAL 5010 – gentian blue

RAL 7035 – light grey

RAL 3004 – crimson red

RAL 7016 – anthracite grey

ESD version available

RAL 7035 – light grey

Width 800 mm

Height 1000 mm - standard duty slide 75 kg



Depth [mm]	525	525	525	525
Version	Standard duty	Standard duty	Standard duty	Standard duty
Quantity of drawers/doors	4, 2	5	6, 2	7
Front height [mm]	2x100, 1x125, 1x150	2x100, 2x200, 1x300	2x100, 2x150, 2x200	2x75, 2x100, 1x150, 2x200
Order ref.	40012031.**V	40012033.**V	40012035.**V	40012100.**V



Depth [mm]	650	650	650	650
Version	Standard duty	Standard duty	Standard duty	Standard duty
Quantity of drawers/doors	4, 2	5	6	7
Front height [mm]	2x100, 1x125, 1x150	2x100, 2x200, 1x300	2x100, 2x150, 2x200	2x75, 2x100, 1x150, 2x200
Order ref.	40020045.**V	40020047.**V	40020049.**V	40020053.**V



Depth [mm]	750	750
Version	Standard duty	Standard duty
Quantity of drawers/doors	7	8
Front height [mm]	2x75, 2x100, 1x150, 2x200	2x75, 4x100, 1x150, 1x200
Order ref.	40028023.**V	40028029.**V



Drawer dividers from page 68

Width 800 mm

Height 1000 mm - heavy duty slide 200 kg



Depth [mm]	650	650	650
Version	Heavy duty	Heavy duty	Heavy duty
Quantity of drawers/doors	5	6	7
Front height [mm]	2x100, 2x200, 1x300	2x100, 2x150, 2x200	2x75, 2x100, 1x150, 2x200
Order ref.	40020048.**V	40020050.**V	40020054.**V



Depth [mm]	750	750	750	750
Version	Heavy duty	Heavy duty	Heavy duty	Heavy duty
Quantity of drawers/doors	5	6	7	8
Front height [mm]	2x100, 2x200, 1x300	2x100, 2x150, 2x200	2x75, 2x100, 1x150, 2x200	2x75, 4x100, 1x150, 1x200
Order ref.	40028018.**V	40028020.**V	40028024.**V	40028030.**



	.11			.24	.19		
Housing: RAL 7035 – light grey	Top, base and fronts: Details on page 15 RAL 5010 – gentian blue RAL 7035 – light grey RAL 3004 – crimson red RAL 7016 – anthracite grey				ESD version available RAL 7035 – light grey		

Width 800 mm

Height 1200 mm - standard duty slide 75 kg



Depth [mm]	650	650	650
Version	Standard duty	Standard duty	Standard duty
Quantity of drawers/doors	7	8	10
Front height [mm]	4x100, 2x200, 1x300	2x75, 1x100, 3x150, 2x200	8x100, 2x150
Order ref.	40020059.**V	40020061.**V	40020065.**V



Depth [mm]	750	750	750
Version	Standard duty	Standard duty	Standard duty
Quantity of drawers/doors	7	8	10
Front height [mm]	4x100, 2x200, 1x300	2x75, 1x100, 3x150, 2x200	8x100, 2x150
Order ref.	40028031.**V	40028033.**V	40028037.**V



Drawer dividers from page 68

Width 800 mm

Height 1200 mm - heavy duty slide 200 kg



Depth [mm]	650	650	650
Version	Heavy duty	Heavy duty	Heavy duty
Quantity of drawers/doors	7	8	10
Front height [mm]	4x100, 2x200, 1x300	2x75, 1x100, 3x150, 2x200	8x100, 2x150
Order ref.	40020060.**V	40020062.**V	40020066.**V



Depth [mm]	750	750	750
Version	Heavy duty	Heavy duty	Heavy duty
Quantity of drawers/doors	7	8	10
Front height [mm]	4x100, 2x200, 1x300	2x75, 1x100, 3x150, 2x200	8x100, 2x150
Order ref.	40028032.**V	40028034.**V	40028038.**V

Width 800 mm

Height 1600 mm - standard duty slide 75 kg



Depth [mm]	650	650	750	750
Version	Standard duty	Standard duty	Standard duty	Standard duty
Quantity of drawers/doors	9	11	9	11
Front height [mm]	2x100, 4x150, 2x200, 1x300	4x100, 2x125, 3x150, 2x200	2x100, 4x150, 2x200, 1x300	4x100, 2x125, 3x150, 2x200
Order ref.	40020067.**V	40020069.**V	40028039.**V	40028041.**V

Height 1600 mm - heavy duty slide 200 kg



Depth [mm]	650	650	750	750
Version	Heavy duty	Heavy duty	Heavy duty	Heavy duty
Quantity of drawers/doors	9	11	9	11
Front height [mm]	2x100, 4x150, 2x200, 1x300	4x100, 2x125, 3x150, 2x200	2x100, 4x150, 2x200, 1x300	4x100, 2x125, 3x150, 2x200
Order ref.	40020068.**V	40020070.**V	40028040.**V	40028042.**V



Drawer dividers from page 68

Width 1050 mm

Height 700 mm - standard duty slide 75 kg



Depth [mm]	650	650	650
Version	Standard duty	Standard duty	Standard duty
Quantity of drawers/doors	2, 2	5	5
Front height [mm]	1x75, 1x100	3x100, 2x150	2x75, 1x100, 1x150, 1x200
Order ref.	40021215.**V	40021217.**V	40021005.**V



Depth [mm]	750	750	750
Version	Standard duty	Standard duty	Standard duty
Quantity of drawers/doors	2, 2	5	5
Front height [mm]	1x75, 1x100	3x100, 2x150	2x75, 1x100, 1x150, 1x200
Order ref.	40029095.**V	40029097.**V	40029005.**V



	.11	.16	.24	.19		.20
Housing: RAL 7035 – light grey	Top, base and fronts: Details on page 15 RAL 5010 – gentian blue RAL 7035 – light grey RAL 3004 – crimson red RAL 7016 – anthracite grey				ESD version available RAL 7035 – light grey	

Width 1050 mm

Height 800 mm - standard duty slide 75 kg



Depth [mm]	650	650	650
Version	Standard duty	Standard duty	Standard duty
Quantity of drawers/doors	4	5	6
Front height [mm]	2x100, 1x200, 1x300	2x100, 2x150, 1x200	2x75, 2x100, 1x150, 1x200
Order ref.	40021007.**V	40021009.**V	40021191.**V



Depth [mm]	750	750	750
Version	Standard duty	Standard duty	Standard duty
Quantity of drawers/doors	4	5	6
Front height [mm]	2x100, 1x200, 1x300	2x100, 2x150, 1x200	2x75, 2x100, 1x150, 1x200
Order ref.	40029007.**V	40029009.**V	40029085.**V



Width 1050 mm

Height 800 mm - heavy duty slide 200 kg



Depth [mm]	650	650	650
Version	Heavy duty	Heavy duty	Heavy duty
Quantity of drawers/doors	4	5	6
Front height [mm]	2x100, 1x200, 1x300	2x100, 2x150, 1x200	2x75, 2x100, 1x150, 1x200
Order ref.	40021008.**V	40021010.**V	40021192.**V



Depth [mm]	750	750	750
Version	Heavy duty	Heavy duty	Heavy duty
Quantity of drawers/doors	4	5	6
Front height [mm]	2x100, 1x200, 1x300	2x100, 2x150, 1x200	2x75, 2x100, 1x150, 1x200
Order ref.	40029008.**V	40029010.**V	40029086.**V

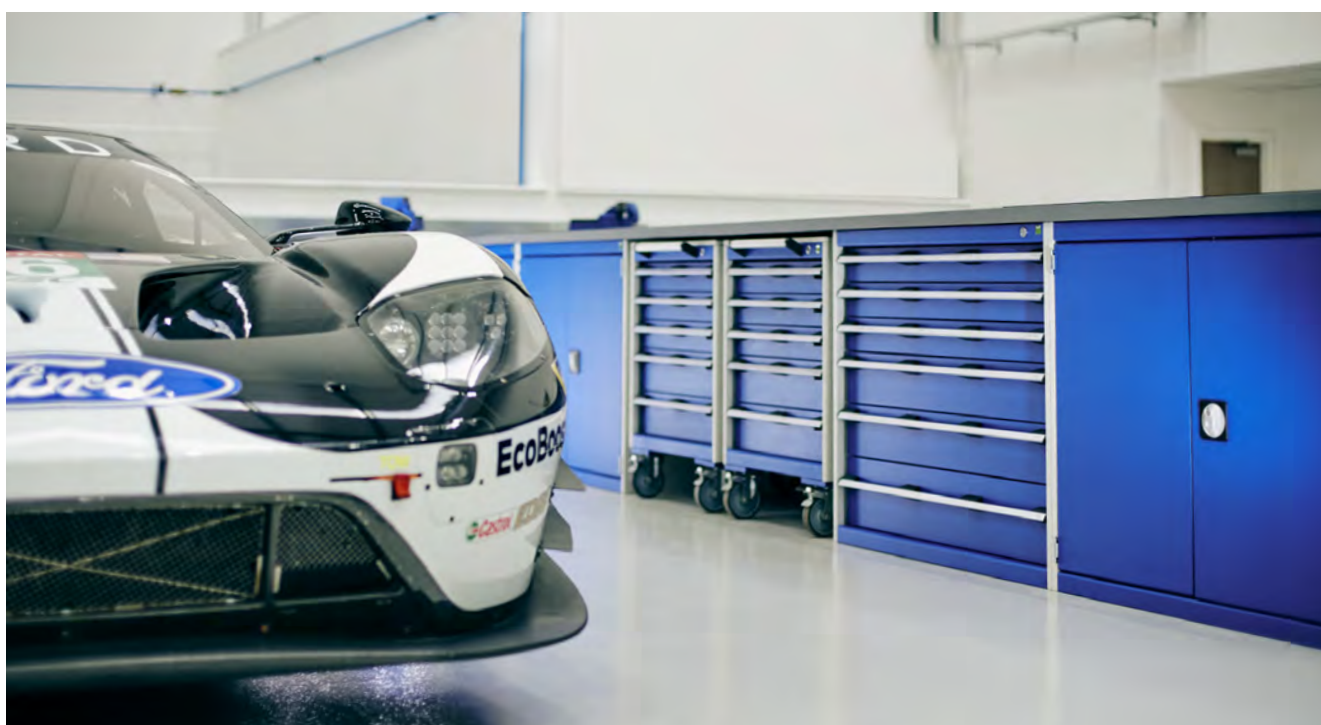

	.11	.16	.24	.19		.20
Housing: RAL 7035 – light grey	Top, base and fronts: Details on page 15 RAL 5010 – gentian blue RAL 7035 – light grey RAL 3004 – crimson red RAL 7016 – anthracite grey				ESD version available RAL 7035 – light grey	

Width 1050 mm

Height 900 mm - standard duty slide 75 kg



Depth [mm]	650	650	650
Version	Standard duty	Standard duty	Standard duty
Quantity of drawers/doors	5	6	7
Front height [mm]	3x100, 1x200, 1x300	3x100, 2x150, 1x200	5x100, 2x150
Order ref.	40021017.**V	40021223.**V	40021021.**V



Depth [mm]	750	750	750
Version	Standard duty	Standard duty	Standard duty
Quantity of drawers/doors	5	6	7
Front height [mm]	3x100, 1x200, 1x300	3x100, 2x150, 1x200	5x100, 2x150
Order ref.	40029093.**V	40029103.**V	40029091.**V



Drawer dividers from page 68

Width 1050 mm

Height 900 mm - heavy duty slide 200 kg



Depth [mm]	650	650	650
Version	Heavy duty	Heavy duty	Heavy duty
Quantity of drawers/doors	5	6	7
Front height [mm]	3x100, 1x200, 1x300	3x100, 2x150, 1x200	5x100, 2x150
Order ref.	40021018.**V	40021224.**V	40021022.**V



Depth [mm]	750	750	750
Version	Heavy duty	Heavy duty	Heavy duty
Quantity of drawers/doors	5	6	7
Front height [mm]	3x100, 1x200, 1x300	3x100, 2x150, 1x200	5x100, 2x150
Order ref.	40029094.**V	40029104.**V	40029092.**V

Width 1050 mm

Height 1000 mm - standard duty slide 75 kg



Depth [mm]	650	650	650
Version	Standard duty	Standard duty	Standard duty
Quantity of drawers/doors	5	6	7
Front height [mm]	2x100, 2x200, 1x300	2x100, 2x150, 2x200	2x75, 2x100, 1x150, 2x200
Order ref.	40021025.**V	40021227.**V	40021029.**V



Depth [mm]	750	750	750
Version	Standard duty	Standard duty	Standard duty
Quantity of drawers/doors	5	6	7
Front height [mm]	2x100, 2x200, 1x300	2x100, 2x150, 2x200	2x75, 2x100, 1x150, 2x200
Order ref.	40029017.**V	40029107.**V	40029021.**V



Drawer dividers from page 68

Width 1050 mm

Height 1000 mm - heavy duty slide 200 kg



Depth [mm]	650	650	650
Version	Heavy duty	Heavy duty	Heavy duty
Quantity of drawers/doors	5	6	7
Front height [mm]	2x100, 2x200, 1x300	2x100, 2x150, 2x200	2x75, 2x100, 1x150, 2x200
Order ref.	40021026.**V	40021228.**V	40021030.**V



Depth [mm]	750	750	750
Version	Heavy duty	Heavy duty	Heavy duty
Quantity of drawers/doors	5	6	7
Front height [mm]	2x100, 2x200, 1x300	2x100, 2x150, 2x200	2x75, 2x100, 1x150, 2x200
Order ref.	40029018.**V	40029108.**V	40029022.**V



Housing:

RAL 7035 – light grey

Top, base and fronts: Details on page 15

RAL 5010 – gentian blue RAL 7035 – light grey RAL 3004 – crimson red RAL 7016 – anthracite grey

ESD version available

RAL 7035 – light grey

Width 1050 mm

Height 1200 mm - standard duty slide 75 kg



Depth [mm]	650	650	650
Version	Standard duty	Standard duty	Standard duty
Quantity of drawers/doors	7	8	10
Front height [mm]	4x100, 2x200, 1x300	2x75, 1x100, 3x150, 2x200	8x100, 2x150
Order ref.	40021037.**V	40021039.**V	40021041.**V



Depth [mm]	750	750	750
Version	Standard duty	Standard duty	Standard duty
Quantity of drawers/doors	7	8	10
Front height [mm]	4x100, 2x200, 1x300	2x75, 1x100, 3x150, 2x200	8x100, 2x150
Order ref.	40029029.**V	40029031.**V	40029033.**V



Width 1050 mm

Height 1200 mm - heavy duty slide 200 kg



Depth [mm]	650	650	650
Version	Heavy duty	Heavy duty	Heavy duty
Quantity of drawers/doors	7	8	10
Front height [mm]	4x100, 2x200, 1x300	2x75, 1x100, 3x150, 2x200	8x100, 2x150
Order ref.	40021038.**V	40021040.**V	40021042.**V



Depth [mm]	750	750	750
Version	Heavy duty	Heavy duty	Heavy duty
Quantity of drawers/doors	7	8	10
Front height [mm]	4x100, 2x200, 1x300	2x75, 1x100, 3x150, 2x200	8x100, 2x150
Order ref.	40029030.**V	40029032.**V	40029034.**V



	.11	.16	.24	.19	 .20
Housing: RAL 7035 – light grey	Top, base and fronts: Details on page 15 RAL 5010 – gentian blue RAL 7035 – light grey RAL 3004 – crimson red RAL 7016 – anthracite grey				ESD version available RAL 7035 – light grey

Width 1050 mm

Height 1600 mm - standard duty slide 75 kg



Depth [mm]	650	650
Version	Standard duty	Standard duty
Quantity of drawers/doors	9	11
Front height [mm]	2x100, 4x150, 2x200, 1x300	4x100, 2x125, 3x150, 2x200
Order ref.	40021043.**V	40021045.**V

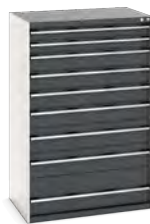

Depth [mm]	750	750
Version	Standard duty	Standard duty
Quantity of drawers/doors	9	11
Front height [mm]	2x100, 4x150, 2x200, 1x300	4x100, 2x125, 3x150, 2x200
Order ref.	40029035.**V	40029037.**V



Drawer dividers from page 68

Width 1050 mm

Height 1600 mm - heavy duty slide 200 kg

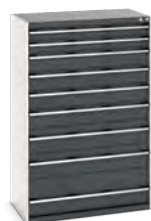

Depth [mm]	650	650
Version	Heavy duty	Heavy duty
Quantity of drawers/doors	9	11
Front height [mm]	2x100, 4x150, 2x200, 1x300	4x100, 2x125, 3x150, 2x200
Order ref.	40021044.**V	40021046.**V

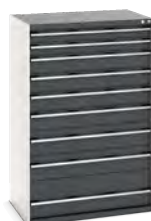

Depth [mm]	750	750
Version	Heavy duty	Heavy duty
Quantity of drawers/doors	9	11
Front height [mm]	2x100, 4x150, 2x200, 1x300	4x100, 2x125, 3x150, 2x200
Order ref.	40029036.**V	40029038.**V



	.11	.16	.24	.19	 .20
Housing: RAL 7035 – light grey	Top, base and fronts: Details on page 15 RAL 5010 – gentian blue RAL 7035 – light grey RAL 3004 – crimson red RAL 7016 – anthracite grey				ESD version available RAL 7035 – light grey

Width 1300 mm

Height 800 mm - standard duty slide 75 kg



Depth [mm]	650	650	650
Version	Standard duty	Standard duty	Standard duty
Quantity of drawers/doors	4	5	6
Front height [mm]	2x100, 1x200, 1x300	2x100, 2x150, 1x200	2x75, 2x100, 1x150, 1x200
Order ref.	40022105.**V	40022107.**V	40022109.**V



Depth [mm]	750	750	750
Version	Standard duty	Standard duty	Standard duty
Quantity of drawers/doors	4	5	6
Front height [mm]	2x100, 1x200, 1x300	2x100, 2x150, 1x200	2x75, 2x100, 1x150, 1x200
Order ref.	40030079.**V	40030007.**V	40030071.**V

Drawer cabinets



Options

Width 1300 mm

Height 800 mm - heavy duty slide 200 kg



Depth [mm]	650	650	650
Version	Heavy duty	Heavy duty	Heavy duty
Quantity of drawers/doors	4	5	6
Front height [mm]	2x100, 1x200, 1x300	2x100, 2x150, 1x200	2x75, 2x100, 1x150, 1x200
Order ref.	40022106.**V	40022108.**V	40022110.**V



Depth [mm]	750	750	750
Version	Heavy duty	Heavy duty	Heavy duty
Quantity of drawers/doors	4	5	6
Front height [mm]	2x100, 1x200, 1x300	2x100, 2x150, 1x200	2x75, 2x100, 1x150, 1x200
Order ref.	40030080.**V	40030008.**V	40030072.**V

	.11	.16	.24	.19		.20
Housing: RAL 7035 – light grey	Top, base and fronts: Details on page 15 RAL 5010 – gentian blue RAL 7035 – light grey RAL 3004 – crimson red RAL 7016 – anthracite grey				ESD version available RAL 7035 – light grey	

Width 1300 mm

Height 900 mm - standard duty slide 75 kg



Depth [mm]	650	650	650
Version	Standard duty	Standard duty	Standard duty
Quantity of drawers/doors	5	6	7
Front height [mm]	3x100, 1x200, 1x300	3x100, 2x150, 1x200	5x100, 2x150
Order ref.	40022113.**V	40022115.**V	40022117.**V



Depth [mm]	750	750	750
Version	Standard duty	Standard duty	Standard duty
Quantity of drawers/doors	5	6	7
Front height [mm]	3x100, 1x200, 1x300	3x100, 2x150, 1x200	5x100, 2x150
Order ref.	40030083.**V	40030085.**V	40030087.**V



Width 1300 mm

Height 900 mm - heavy duty slide 200 kg



Depth [mm]	650	650	650
Version	Heavy duty	Heavy duty	Heavy duty
Quantity of drawers/doors	5	6	7
Front height [mm]	3x100, 1x200, 1x300	3x100, 2x150, 1x200	5x100, 2x150
Order ref.	40022114.**V	40022116.**V	40022118.**V



Depth [mm]	750	750	750
Version	Heavy duty	Heavy duty	Heavy duty
Quantity of drawers/doors	5	6	7
Front height [mm]	3x100, 1x200, 1x300	3x100, 2x150, 1x200	5x100, 2x150
Order ref.	40030084.**V	40030086.**V	40030088.**V



	.11	.16	.24	.19		.20
Housing: RAL 7035 – light grey	Top, base and fronts: Details on page 15 RAL 5010 – gentian blue RAL 7035 – light grey RAL 3004 – crimson red RAL 7016 – anthracite grey				ESD version available RAL 7035 – light grey	

Width 1300 mm

Height 1000 mm - standard duty slide 75 kg



Depth [mm]	650	650	650
Version	Standard duty	Standard duty	Standard duty
Quantity of drawers/doors	5	6	7
Front height [mm]	2x100, 2x200, 1x300	2x100, 2x150, 2x200	2x75, 2x100, 1x150, 2x200
Order ref.	40022121.**V	40022123.**V	40022125.**V



Depth [mm]	750	750	750
Version	Standard duty	Standard duty	Standard duty
Quantity of drawers/doors	5	6	7
Front height [mm]	2x100, 2x200, 1x300	2x100, 2x150, 2x200	2x75, 2x100, 1x150, 2x200
Order ref.	40030091.**V	40030093.**V	40030015.**V



Width 1300 mm

Height 1000 mm - heavy duty slide 200 kg



Depth [mm]	650	650	650
Version	Heavy duty	Heavy duty	Heavy duty
Quantity of drawers/doors	5	6	7
Front height [mm]	2x100, 2x200, 1x300	2x100, 2x150, 2x200	2x75, 2x100, 1x150, 2x200
Order ref.	40022122.**V	40022124.**V	40022126.**V



Depth [mm]	750	750	750
Version	Heavy duty	Heavy duty	Heavy duty
Quantity of drawers/doors	5	6	7
Front height [mm]	2x100, 2x200, 1x300	2x100, 2x150, 2x200	2x75, 2x100, 1x150, 2x200
Order ref.	40030092.**V	40030094.**V	40030016.**V



Housing: RAL 7035 – light grey

Top, base and fronts: Details on page 15

RAL 5010 – gentian blue RAL 7035 – light grey RAL 3004 – crimson red RAL 7016 – anthracite grey RAL 7035 – light grey

ESD version available

Width 1300 mm

Height 1200 mm - standard duty slide 75 kg



Depth [mm]	650	650	650
Version	Standard duty	Standard duty	Standard duty
Quantity of drawers/doors	7	8	10
Front height [mm]	4x100, 2x200, 1x300	2x75, 1x100, 3x150, 2x200	8x100, 2x150
Order ref.	40022127.**V	40022129.**V	40022131.**V



Depth [mm]	750	750	750
Version	Standard duty	Standard duty	Standard duty
Quantity of drawers/doors	7	8	10
Front height [mm]	4x100, 2x200, 1x300	2x75, 1x100, 3x150, 2x200	8x100, 2x150
Order ref.	40030073.**V	40030021.**V	40030025.**V



Drawer dividers from page 68

Width 1300 mm

Height 1200 mm - heavy duty slide 200 kg



Depth [mm]	650	650	650
Version	Heavy duty	Heavy duty	Heavy duty
Quantity of drawers/doors	7	8	10
Front height [mm]	4x100, 2x200, 1x300	2x75, 1x100, 3x150, 2x200	8x100, 2x150
Order ref.	40022128.**V	40022130.**V	40022132.**V



Depth [mm]	750	750	750
Version	Heavy duty	Heavy duty	Heavy duty
Quantity of drawers/doors	7	8	10
Front height [mm]	4x100, 2x200, 1x300	2x75, 1x100, 3x150, 2x200	8x100, 2x150
Order ref.	40030074.**V	40030022.**V	40030026.**V

Width 1300 mm

Height 1600 mm - standard duty slide 75 kg



Depth [mm]	650	650
Version	Standard duty	Standard duty
Quantity of drawers/doors	9	11
Front height [mm]	2x100, 4x150, 2x200, 1x300	4x100, 2x125, 3x150, 2x200
Order ref.	40022133.**V	40022135.**V



Depth [mm]	750	750
Version	Standard duty	Standard duty
Quantity of drawers/doors	9	11
Front height [mm]	2x100, 4x150, 2x200, 1x300	4x100, 2x125, 3x150, 2x200
Order ref.	40030075.**V	40030029.**V



60 Drawer dividers from page 68

Width 1300 mm

Height 1600 mm - heavy duty slide 200 kg



Depth [mm]	650	650
Version	Heavy duty	Heavy duty
Quantity of drawers/doors	9	11
Front height [mm]	2x100, 4x150, 2x200, 1x300	4x100, 2x125, 3x150, 2x200
Order ref.	40022134.**V	40022136.**V

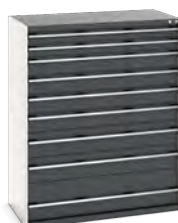

Depth [mm]	750	750
Version	Heavy duty	Heavy duty
Quantity of drawers/doors	9	11
Front height [mm]	2x100, 4x150, 2x200, 1x300	4x100, 2x125, 3x150, 2x200
Order ref.	40030076.**V	40030030.**V

Cleaning and disposal

Waste disposal with front flap



- Swivelling hinged flap above the drawer for disposing recyclables
- Zinc-plated drawer with full extension slide
- Rear panel with perfo louvred form for ventilation
- Load capacity up to 200 kg per drawer
- 1-3 aluminium containers for sorting waste, with side handle recesses

Dimensions W x D x H [mm]	650 x 650 x 900	800 x 650 x 900	1050 x 650 x 900	1300 x 650 x 900
Container volume in [l]	1x 116	2x 74	3x 67	2x 74, 1x 116
Order ref.	40019172.**V	40020158.**V	40021247.**V	40022151.**V

Assembly cabinet with collapsible lift and vice 125 mm



- With high-quality forged steel vice
- Vice 120 mm jaw width, max. jaw opening 120 mm, for pipes up to 3" in diameter
- Hardened jaw and anvil
- Height adjustment range of 155 mm
- When not in use the vice disappears behind the lockable hinged door

Dimensions W x D x H [mm]	400 x 650 x 900
Version	Hinged lift and vice
Work height min. - max. [mm]	1150-1320
Order ref.	40017105.**V



Drawer dividers from page 68

Mobile drawer cabinets Width 525 mm

Mobile drawer cabinets

- Load-bearing capacity including cabinet weight: 300 kg except W 800/1050 x 650 mm: 600 kg
- Built-in drawer trigger locks
- Mechanical central locking system
- Max. load per drawer: 50 kg
- 2 swivel & brake castors, 2 fixed castors
- Delivery condition: Castors and handle assembled
- Anti roll-off lip with anti-slip mat



Width 525 mm



Depth [mm]	525	525	525
Height [mm]	785	785	785
Quantity of drawers/doors	3	4	5
Front height [mm]	2x100, 1x300	3x100, 1x200	2x75, 2x100, 1x150
Order ref.	40402007.**V	40402109.**V	40402011.**V

	.11	.16	.24	.19	 .20
Housing: RAL 7035 – light grey	Top, base and fronts: Details on page 15 RAL 5010 – gentian blue RAL 7035 – light grey RAL 3004 – crimson red RAL 7016 – anthracite grey				ESD version available RAL 7035 – light grey

Mobile drawer cabinets



Depth [mm]	525	525	525	525
Height [mm]	885	885	985	985
Quantity of drawers/doors	5	5	5	7
Front height [mm]	3x 100, 2x 150	2x75, 1x100, 1x150, 1x200	2x100, 2x150, 1x200	4x75, 1x100, 2x150
Order ref.	40402132.**V	40402106.**V	40402019.**V	40402021.**V



Depth [mm]	650	650
Height [mm]	785	885
Quantity of drawers/doors	4	5
Front height [mm]	3x100, 1x200	2x75, 1x100, 1x150, 1x200
Order ref.	40402111.**V	40402113.**V



Mobile drawer cabinets

Width 650 mm



Depth [mm]	525	525	525
Height [mm]	785	885	985
Quantity of drawers/doors	4	5	5
Front height [mm]	3x100, 1x200	2x75, 1x100, 1x150, 1x200	2x100, 2x150, 1x200
Order ref.	40402115.**V	40402117.**V	40402119.**V



Depth [mm]	650	650	650
Height [mm]	785	785	885
Quantity of drawers/doors	4	5	5
Front height [mm]	3x100, 1x200	5x100	2x75, 1x100, 1x150, 1x200
Order ref.	40402023.**V	40402027.**V	40402122.**V



Depth [mm]	650	650	650
Height [mm]	885	985	985
Quantity of drawers/doors	5	5	6
Front height [mm]	3x100, 2x150	2x100, 2x150, 1x200	2x75, 2x100, 1x150, 1x200
Order ref.	40402031.**V	40402033.**V	40402035.**V

Mobile drawer cabinets

Width 800 mm



Depth [mm]	525	525
Height [mm]	885	985
Quantity of drawers/doors	5	5
Front height [mm]	2x75, 1x100, 1x150, 1x200	2x100, 2x150, 1x200
Order ref.	40402102.**V	40402047.**V



Depth [mm]	650	650	650
Height [mm]	785	885	885
Quantity of drawers/doors	5	5	5
Front height [mm]	2x75, 2x100, 1x150	2x75, 1x100, 1x150, 1x200	3x100, 2x150
Order ref.	40402107.**V	40402104.**V	40402057.**V



Depth [mm]	650	650	650
Height [mm]	985	1085	1085
Quantity of drawers/doors	5	6	7
Front height [mm]	2x100, 2x150, 1x200	3x100, 2x150, 1x200	2x75, 3x100, 1x150, 1x200
Order ref.	40402059.**V	40402063.**V	40402065.**V



Drawer dividers from page 68

Mobile drawer cabinets

Width 1050 mm



Depth [mm]	525	525
Height [mm]	885	885
Quantity of drawers/doors	4, 1	5, 1
Front height [mm]	1x100, 2x150, 1x200	2x75, 1x100, 1x150, 1x200
Order ref.	41006006.**V	41006009.**V



Depth [mm]	525	525
Height [mm]	885	885
Quantity of drawers/doors	4, 1	5, 1
Front height [mm]	1x100, 2x150, 1x200	2x75, 1x100, 1x150, 1x200
Order ref.	41006012.**V	41006015.**V



Depth [mm]	650	650
Height [mm]	885	985
Quantity of drawers/doors	5	5
Front height [mm]	2x75, 1x100, 1x150, 1x200	2x100, 2x150, 1x200
Order ref.	40402130.**V	40402075.**V

Drawer dividers



Drawer dividers

Drawer dividers



Small parts storage boxes

- Material: Polystyrene (PS), impact-resistant
- Colour: light grey (RAL 7035)
- ESD version available
- Rounded corners for easy removal of small parts
- Optional labelling with label holders



Trough blocks

- Material: ABS, impact-resistant
- Colour: iron grey (RAL 7011)
- ESD version available
- Custom subdivision in depth in 15 mm increments via cross dividers
- Height of trough blocks: 28 mm

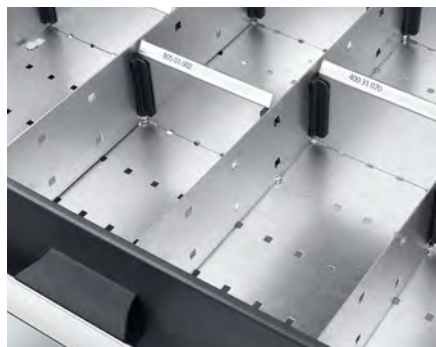

Dividers and cross dividers

- Galvanised sheet steel
- Optional labelling with labelling kit
- Low noise thanks to plastic divider clips



Drawer accessories

- Foam inserts and non-slip mats
- Holders for milling cutters and tools

Divider/cross divider kits

Cabinet dimensions width 525 mm



- Partitions and cross dividers for customised drawer division
- Further customisation possible through use of additional cross divider kits
- Optional labelling with labelling kit
- Material: Sheet steel, galvanised
- Low noise thanks to plastic divider clips

Cabinet dimensions width 525 mm



For system depth [mm]	525					
Quantity of dividers	1			2		
Quantity of cross dividers	4			5		
Front height of drawer [mm]	75	100/125	starting from 150	75	100/125	starting from 150
Height of the cross dividers [mm]	75	100	150	75	100	150
Order ref.	43020622.51	43020624.51	43020626.51	43020623.51	43020625.51	43020627.51

Drawer dividers



70 Labelling kits from page 68



Drawer accessories from page 88

Options

Divider/cross divider kits

Cabinet dimensions width 525 mm



For system depth [mm]	650					
Quantity of dividers	1			2		
Quantity of cross dividers	4			5		
Front height of drawer [mm]	75	100/125	starting from 150	75	100/125	starting from 150
Height of the cross dividers [mm]	75	100	150	75	100	150
Order ref.	43020628.51	43020630.51	43020632.51	43020629.51	43020631.51	43020633.51

Cabinet dimensions width 650 mm



For system depth [mm]	525					
Quantity of dividers	2			3		
Quantity of cross dividers	5					
Front height of drawer [mm]	75	100/125	starting from 150	75	100/125	starting from 150
Height of the cross dividers [mm]	150	100	150	75	100	150
Order ref.	43020634.51	43020636.51	43020638.51	43020635.51	43020637.51	43020639.51

Divider/cross divider kits

Cabinet dimensions width 650 mm



For system depth [mm]	650					
Quantity of dividers	2			3		
Quantity of cross dividers	7			5		
Front height of drawer [mm]	75	100/125	starting from 150	75	100/125	starting from 150
Height of the cross dividers [mm]	75	100	150	75	100	150
Order ref.	43020640.51	43020642.51	43020644.51	43020641.51	43020643.51	43020645.51

Cabinet dimensions width 800 mm



For system depth [mm]	525					
Quantity of dividers	3			4		
Quantity of cross dividers	7			10		
Front height of drawer [mm]	75	100/125	starting from 150	75	100/125	starting from 150
Height of the cross dividers [mm]	75	100	150	75	100	150
Order ref.	43020652.51	43020654.51	43020656.51	43020653.51	43020655.51	43020657.51

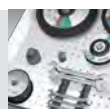

Divider/cross divider kits

Cabinet dimensions width 800 mm



For system depth [mm]	650					
Quantity of dividers	3			4		
Quantity of cross dividers	7			10		
Front height of drawer [mm]	75	100/125	starting from 150	75	100/125	starting from 150
Height of the cross dividers [mm]	75	100	150	75	100	150
Order ref.	43020658.51	43020660.51	43020662.51	43020659.51	43020661.51	43020663.51

Cabinet dimensions width 800 mm



For system depth [mm]	750					
Quantity of dividers	3			4		
Quantity of cross dividers	7			10		
Front height of drawer [mm]	75	100/125	starting from 150	75	100/125	starting from 150
Height of the cross dividers [mm]	75	100	150	75	100	150
Order ref.	43020664.51	43020666.51	43020668.51	43020665.51	43020667.51	43020669.51



Divider/cross divider kits

Cabinet dimensions width 1050 mm



For system depth [mm]	650					
Quantity of dividers	5			4		
Quantity of cross dividers	7			11		
Front height of drawer [mm]	75	100/125	starting from 150	75	100/125	starting from 150
Height of the cross dividers [mm]	75	100	150	75	100	150
Order ref.	43020676.51	43020678.51	43020680.51	43020677.51	43020679.51	43020681.51

Cabinet dimensions width 1050 mm



For system depth [mm]	750					
Quantity of dividers	5			4		
Quantity of cross dividers	7			11		
Front height of drawer [mm]	75	100/125	starting from 150	75	100/125	starting from 150
Height of the cross dividers [mm]	75	100	150	75	100	150
Order ref.	43020682.51	43020684.51	43020686.51	43020683.51	43020685.51	43020687.51

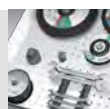

Divider/cross divider kits

Cabinet dimensions width 1300 mm

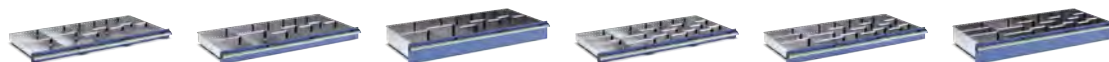

For system depth [mm]	650					
Quantity of dividers	6					
Quantity of cross dividers	7			14		
Front height of drawer [mm]	75	100/125	starting from 150	75	100/125	starting from 150
Height of the cross dividers [mm]	75	100	150	75	100	150
Order ref.	43020694.51	43020696.51	43020698.51	43020695.51	43020697.51	43020699.51

Cabinet dimensions width 1300 mm

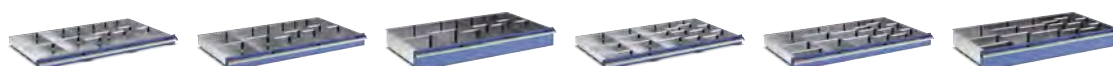

For system depth [mm]	750					
Quantity of dividers	6			5		
Quantity of cross dividers	7			14		
Front height of drawer [mm]	75	100/125	starting from 150	75	100/125	starting from 150
Height of the cross dividers [mm]	75	100	150	75	100	150
Order ref.	43020700.51	43020702.51	43020704.51	43020701.51	43020703.51	43020705.51

Dividers/cross dividers

Dividers

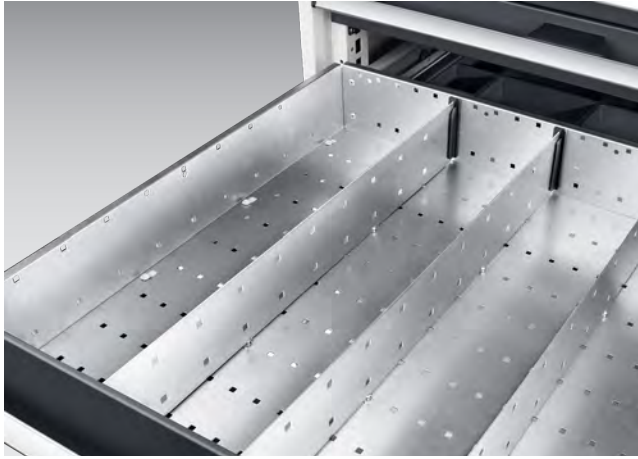

- Partitions for front to back drawer division
- Fixings included
- Material: Sheet steel, galvanised

For system depth [mm]	525	525	525	650	650	650	750	750	750
Pack of	3	3	3	3	3	3	3	3	3
Order ref.	43001013.51	43001016.51	43001019.51	43001014.51	43001017.51	43001020.51	43001015.51	43001018.51	43001021.51

Cross divider sets



- Cross dividers for left to right drawer division in a 50 mm pitch
- incl. Fixing kit
- 3x cross divider with width 125 mm
- 2x cross divider with width 150 mm
- 2x cross divider with width 250 mm
- Material: Sheet steel, zinc-plated

Quantity of cross dividers	7	7	7
Front height of drawer [mm]	75	100	150
Height of the cross dividers [mm]	52	77	127
Order ref.	43002074.51	43002075.51	43002076.51

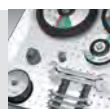

Dividers/cross dividers

Cross dividers to supplement kits

Cross divider width [mm]	50	50	50	75	75	75
Cross divider height [mm]	52	77	127	52	77	127
Pack of	5	5	5	5	5	5
Order ref.	43002044.51	43002054.51	43002064.51	43002045.51	43002055.51	43002065.51

Cross divider width [mm]	100	100	100	125	125	125
Cross divider height [mm]	52	77	127	52	77	127
Pack of	5	5	5	5	5	5
Order ref.	43002046.51	43002056.51	43002066.51	43002047.51	43002057.51	43002067.51

Cross divider width [mm]	150	150	150	175	175	175
Cross divider height [mm]	52	77	127	52	77	127
Pack of	5	5	5	5	5	5
Order ref.	43002048.51	43002058.51	43002068.51	43002049.51	43002059.51	43002069.51

Cross divider width [mm]	200	200	200	250	250	250
Cross divider height [mm]	52	77	127	52	77	127
Pack of	5	5	5	5	5	5
Order ref.	43002050.51	43002060.51	43002070.51	43002051.51	43002061.51	43002071.51

Cross divider width [mm]	300	300	300	350	350	350
Cross divider height [mm]	52	77	127	52	77	127
Pack of	5	5	5	5	5	5
Order ref.	43002052.51	43002062.51	43002072.51	43002053.51	43002063.51	43002073.51

Dividers/cross dividers

Labelling kit for cross dividers



- For neatly labeling cross dividers
- 10 x sheets of perforated DIN A4 Paper each with 40 labeling strips (7mm in height)
- 3 x transparent clips for 125mm wide cross dividers
- 2 x transparent clips for 150mm wide cross dividers
- 2 x transparent clips for 250mm wide cross dividers

Weight [kg]	0.14
Order ref.	43020707

Kits - small parts storage boxes



- For the clear and orderly storage of small parts
- Complete kits for the simple, fast and customised subdivision of drawers
- **Height 50 mm**
 - Suitable for cubio drawers with front height 75 mm
 - Rounded corners for easy removal of small parts
 - Optional labelling with label holders
- **Height 68 mm**
 - Suitable for cubio drawers with front height 100 mm, bott vario3 drawers, systainer³ organizers and varioCase service cases
 - Rounded corners for easy removal of small parts
 - boxes can be labelled with the addition of a label clip - ideal for label printers with a height of 12 mm

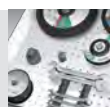

Small parts storage box kits

Cabinet dimensions width 525 mm

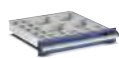

For system depth [mm]	525	525	525
Quantity of small parts storage boxes 50 x 50 [mm]	4	4	4
Quantity of small parts storage boxes 50 x 75 [mm]		16	16
Quantity of small parts storage boxes 100 x 150 [mm]	4		
Quantity of small parts storage boxes 150 x 150 [mm]		4	4
Quantity of small parts storage boxes 300 x 150 [mm]	2		
Front height of drawer [mm]	starting from 100	starting from 75	starting from 100
Box height [mm]	100	75	100
Order ref.	43020750	43020793	43020752

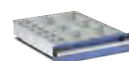

For system depth [mm]	650	650	650
Quantity of small parts storage boxes 50 x 75 [mm]	2	14	14
Quantity of small parts storage boxes 75 x 75 [mm]		4	4
Quantity of small parts storage boxes 75 x 150 [mm]	2		
Quantity of small parts storage boxes 100 x 150 [mm]	3		
Quantity of small parts storage boxes 150 x 150 [mm]		6	6
Quantity of small parts storage boxes 300 x 150 [mm]	3		
Front height of drawer [mm]	starting from 100	starting from 75	starting from 100
Box height [mm]	100	75	100
Order ref.	43020753	43020795	43020755

Small parts storage box kits

Cabinet dimensions width 650 mm



For system depth [mm]	525	525	525
Quantity of small parts storage boxes 50 x 75 [mm]	2	14	14
Quantity of small parts storage boxes 75 x 75 [mm]		4	4
Quantity of small parts storage boxes 75 x 150 [mm]	2		
Quantity of small parts storage boxes 100 x 150 [mm]	3		
Quantity of small parts storage boxes 150 x 150 [mm]		6	6
Quantity of small parts storage boxes 300 x 150 [mm]	3		
Front height of drawer [mm]	starting from 100	starting from 75	starting from 100
Box height [mm]	100	75	100
Order ref.	43020756	43020797	43020758



For system depth [mm]	650	650	650
Quantity of small parts storage boxes 75 x 75 [mm]	1	13	13
Quantity of small parts storage boxes 75 x 150 [mm]	6		
Quantity of small parts storage boxes 150 x 150 [mm]	3	9	9
Quantity of small parts storage boxes 300 x 150 [mm]	3		
Front height of drawer [mm]	starting from 100	starting from 75	starting from 100
Box height [mm]	100	75	100
Order ref.	43020759	43020799	43020761



Small parts storage box kits

Cabinet dimensions width 800 mm

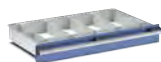

For system depth [mm]	525	525	525
Quantity of small parts storage boxes 50 x 75 [mm]	2	18	18
Quantity of small parts storage boxes 75 x 75 [mm]		4	4
Quantity of small parts storage boxes 75 x 150 [mm]	2		
Quantity of small parts storage boxes 100 x 150 [mm]	4		
Quantity of small parts storage boxes 150 x 150 [mm]		8	8
Quantity of small parts storage boxes 300 x 150 [mm]	4		
Front height of drawer [mm]	starting from 100	starting from 75	starting from 100
Box height [mm]	100	75	100
Order ref.	43020765	43020803	43020767



For system depth [mm]	650	650	650
Quantity of small parts storage boxes 75 x 75 [mm]	1	15	15
Quantity of small parts storage boxes 75 x 150 [mm]	7		
Quantity of small parts storage boxes 150 x 150 [mm]	4	12	12
Quantity of small parts storage boxes 300 x 150 [mm]	4		
Front height of drawer [mm]	starting from 100	starting from 75	starting from 100
Box height [mm]	100	75	100
Order ref.	43020768	43020805	43020770

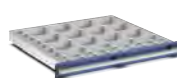

For system depth [mm]	650	750	750
Quantity of small parts storage boxes 50 x 75 [mm]	2	18	18
Quantity of small parts storage boxes 75 x 75 [mm]	1	7	7
Quantity of small parts storage boxes 75 x 150 [mm]	7	4	4
Quantity of small parts storage boxes 100 x 150 [mm]	4		
Quantity of small parts storage boxes 150 x 150 [mm]		12	12
Quantity of small parts storage boxes 300 x 150 [mm]	6		
Front height of drawer [mm]	starting from 100	starting from 75	starting from 100
Box height [mm]	100	75	100
Order ref.	43020771	43020807	43020773

Small parts storage box kits

Cabinet dimensions width 1050 mm

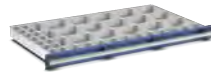

For system depth [mm]	750	650	650
Quantity of small parts storage boxes 50 x 75 [mm]	2	14	14
Quantity of small parts storage boxes 75 x 75 [mm]	1	11	11
Quantity of small parts storage boxes 75 x 150 [mm]	8	3	3
Quantity of small parts storage boxes 100 x 150 [mm]	3		
Quantity of small parts storage boxes 150 x 150 [mm]	5	15	15
Quantity of small parts storage boxes 300 x 150 [mm]	5		
Front height of drawer [mm]	starting from 100	starting from 75	starting from 100
Box height [mm]	100	75	100
Order ref.	43020774	43020809	43020776

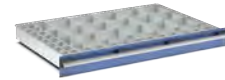

For system depth [mm]	650	750	750
Quantity of small parts storage boxes 50 x 50 [mm]	4	4	4
Quantity of small parts storage boxes 50 x 75 [mm]	4	36	36
Quantity of small parts storage boxes 75 x 75 [mm]	1	1	1
Quantity of small parts storage boxes 75 x 150 [mm]	8	8	8
Quantity of small parts storage boxes 100 x 150 [mm]	8		
Quantity of small parts storage boxes 150 x 150 [mm]	1	15	15
Quantity of small parts storage boxes 300 x 150 [mm]	7		
Front height of drawer [mm]	starting from 100	starting from 75	starting from 100
Box height [mm]	100	75	100
Order ref.	43020777	43020811	43020779

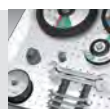

Small parts storage box kits

Cabinet dimensions width 1300 mm

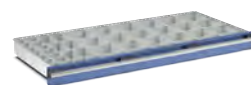

For system depth [mm]	650	650	650
Quantity of small parts storage boxes 50 x 75 [mm]	7	7	7
Quantity of small parts storage boxes 75 x 75 [mm]	1	9	9
Quantity of small parts storage boxes 75 x 150 [mm]	10	12	12
Quantity of small parts storage boxes 150 x 150 [mm]	7	18	18
Quantity of small parts storage boxes 300 x 150 [mm]	7		
Front height of drawer [mm]	starting from 100	starting from 75	starting from 100
Box height [mm]	100	75	100
Order ref.	43020783	43020815	43020785

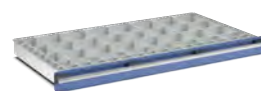

For system depth [mm]	750	750	750
Quantity of small parts storage boxes 50 x 50 [mm]	2	2	2
Quantity of small parts storage boxes 50 x 75 [mm]	9	37	37
Quantity of small parts storage boxes 75 x 75 [mm]	1	1	1
Quantity of small parts storage boxes 75 x 150 [mm]	10	10	10
Quantity of small parts storage boxes 100 x 150 [mm]	7		
Quantity of small parts storage boxes 150 x 150 [mm]	1	21	21
Quantity of small parts storage boxes 300 x 150 [mm]	10		
Front height of drawer [mm]	starting from 100	starting from 75	starting from 100
Box height [mm]	100	75	100
Order ref.	43020786	43020817	43020788

Labelling kit

Labelling kit



- 30 label clips made of transparent plastic
- 10 sheets of pre-perforated DIN A4 paper with 40 labelling strips each

Weight [kg]	0.13
Order ref.	43020003

Labelling kit for small parts boxes



- 40 Label clips made of transparent plastic
- Ideally matched to label printer with 12 mm height

Weight [kg]	0.20
Order ref.	72522039.90V

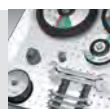

Trough block kits

Kits with trough blocks



- Trough blocks for customised division of drawers
- Including cross dividers for subdivision of trough blocks on a 15mm pitch
- Material: impact-resistant ABS
- Colour: iron grey (RAL 7011)
- With general storage channel for maximum utilisation of the drawers

Cabinet dimensions width 525 mm



For system depth [mm]	525	650
Quantity of trough blocks with trough width 70 [mm]	2	2
Quantity of trough blocks with trough width 45 [mm]	3	3
Quantity of cross dividers for trough width 70 [mm]	4	6
Quantity of cross dividers for trough width 45 [mm]	6	9
Storage channel	1	1
Order ref.	43020004	43020019

Cabinet dimensions width 650 mm



For system depth [mm]	525	650
Quantity of trough blocks with trough width 70 [mm]	2	2
Quantity of trough blocks with trough width 45 [mm]	3	3
Quantity of trough blocks with trough width 33 [mm]	4	4
Quantity of cross dividers for trough width 70 [mm]	4	6
Quantity of cross dividers for trough width 45 [mm]	6	9
Quantity of cross dividers for trough width 33 [mm]	8	12
Storage channel	1	1
Order ref.	43020007	43020022

Trough block kits

Cabinet dimensions width 800 mm

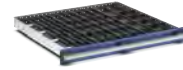

For system depth [mm]	525	650	750
Quantity of trough blocks with trough width 70 [mm]	2	2	2
Quantity of trough blocks with trough width 45 [mm]	6	6	6
Quantity of trough blocks with trough width 33 [mm]	4	4	4
Quantity of cross dividers for trough width 70 [mm]	4	6	8
Quantity of cross dividers for trough width 45 [mm]	12	18	24
Quantity of cross dividers for trough width 33 [mm]	8	12	16
Storage channel	1	1	1
Order ref.	43020010	43020025	43020040

Cabinet dimensions width 1050 mm

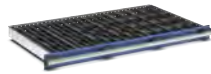

For system depth [mm]	650	750
Quantity of trough blocks with trough width 70 [mm]	4	4
Quantity of trough blocks with trough width 45 [mm]	6	6
Quantity of trough blocks with trough width 33 [mm]	8	8
Quantity of cross dividers for trough width 70 [mm]	12	16
Quantity of cross dividers for trough width 45 [mm]	18	24
Quantity of cross dividers for trough width 33 [mm]	24	32
Storage channel	1	1
Order ref.	43020028	43020043

Cabinet dimensions width 1300 mm

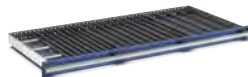

For system depth [mm]	650	750
Quantity of trough blocks with trough width 70 [mm]	4	4
Quantity of trough blocks with trough width 45 [mm]	9	9
Quantity of trough blocks with trough width 33 [mm]	8	8
Quantity of cross dividers for trough width 70 [mm]	12	16
Quantity of cross dividers for trough width 45 [mm]	27	36
Quantity of cross dividers for trough width 33 [mm]	24	32
Storage channel	1	1
Order ref.	43020031	43020046

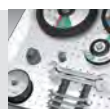

Accessories for trough blocks

Cross dividers for trough blocks



- For subdivision of trough blocks
- Material: impact-resistant ABS
- Colour: iron grey (RAL 7011)

Cross dividers for trough width [mm]	70	45	33
Pack of	20	20	20
Order ref.	13002293	13002294	13002295

Foam inlays for custom trimming



- Clear arrangement of tools
- Unique definition of storage locations and contents
- Missing items immediately noticed
- Cut-outs can be accurately made using a cutter set
- Can be adjusted to other drawer sizes by trimming or by using multiple mats
- Material/colour: Underlay: XPE 33, thickness 5 mm / red Inlay: PE 30, thickness 22 mm / black
- Properties: PE 30 laminated, heat-resistant up to 112 °C, non-combustible, resistant to oils, petrol and detergents, environmentally friendly
- Cutting knife included

For system dimensions W x D [mm]	525 x 525	650 x 525	650 x 650	800 x 525	800 x 650
Actual dimensions in [mm]	400 x 400	525 x 400	525 x 525	675 x 400	675 x 525
Order ref.	13017004.10V	13017005.10V	13017009.10V	13017006.10V	13017002.10V

For system dimensions W x D [mm]	800 x 750	1050 x 650	1050 x 750	1300 x 650	1300 x 750
Actual dimensions in [mm]	675 x 625	925 x 525	925 x 625	1175 x 525	1175 x 625
Order ref.	13017019.10V	13017010.10V	13017020.10V	13017011.10V	13017021.10V

Divider components

Cutter set for custom trimming incl. storage case



- 3 Cutters with protective covers 1x width 20 mm, 1x width 50 mm, 1x semicircular, 20 x 20 x 80 mm
- Incl. cutter knife
- Folding rule

Dimensions W x D x H [mm]

225 x 170 x 45

Order ref.

13017001.10V

Labelling kit for drawer handle



- 10 sheets of pre-perforated DIN A4 paper with 12 labelling strips each
- Height strips: 16 mm

Weight [kg]

0.10

Order ref.

43020001

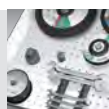

Divider components

Anti-slip mats for drawers



- Material: hard-wearing, tear-resistant PES glass fibre fabric with PVC coating both sides
- Properties: anti-slip, durable, oil and fat resistant, washable up to 60 °C, not resistant to solvents, petrol, diesel and heating oil

For system width [mm]	525	650	650	650	800
For system depth [mm]	525	525	650	750	525
Order ref.	41301003	41301005	41301006	41301007	41301008

For system width [mm]	800	800	1050	1050	1300	1300
For system depth [mm]	650	750	650	750	650	750
Order ref.	41301009	41301010	41301012	41301013	41301015	41301016

Milling cutter holder



- Milling cutter holders can also be screwed above each other (except Ø 10 mm)
- Colour: iron grey (RAL 7011)
- Material: Polystyrene (PS), impact-resistant

Ø [mm]	10	13	16	22	27	32	40	50
Height [mm]	24	26	26	26	26	26	26	26
Pack of	5	5	5	5	5	5	5	5
Order ref.	13007017	13007018	13007019	13007020	13007021	13007022	13007023	13007024

Divider components

Clip strip



- With resilient plastic sprung loops
- Width 150 mm with 5 clip positions, Width 300 mm with 13 clip positions
- For holding tools and other parts
- Material: Base carrier: Anodised aluminium, Clips: Plastic
- Fixings included
- Colour: black

Dimensions W x D x H [mm]	150 x 37 x 29	300 x 37 x 28
Pack of	3	3
Order ref.	13008008	13008009

Support bracket



- For fixing electrical tools in place
- Material: Polystyrene (PS), impact-resistant
- Fixings included
- Colour: iron grey (RAL 7011)



Dimensions W x D x H [mm]	80 x 20 x 60
Pack of	4
Order ref.	13009008



90 Labelling kits from page 68

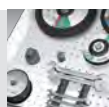

Drawer accessories from page 88

Divider components

Prism rack

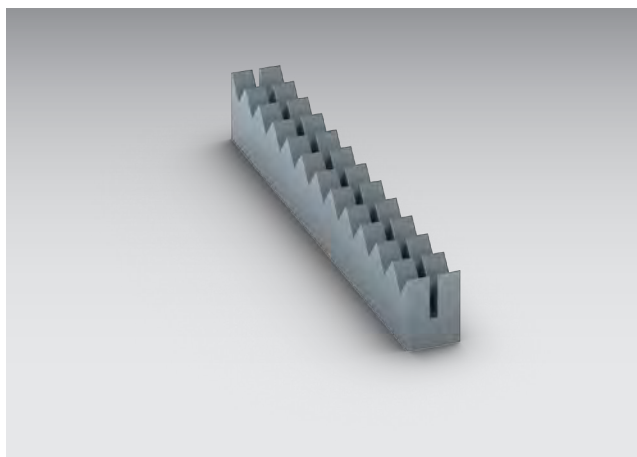

- Prism rack made of plastic
- Allows for larger parts and measuring tools to be held
- Colour: iron grey (RAL 7011)
- Material: Polystyrene (PS), impact-resistant



Dimensions W x D x H [mm]	15 x 160 x 20	15 x 160 x 20
Prism rack spacer [mm]	12	20
Pack of	4	4
Order ref.	13006010	13006011

Spacer for prism rack



- Prism rack spacer to be mounted below the prism rack
- Allows for larger parts and measuring tools to be held
- Colour: iron grey (RAL 7011)
- Material: Polystyrene (PS), impact-resistant

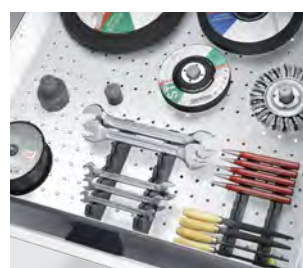

Dimensions W x D x H [mm]	15 x 160 x 20
Pack of	4
Order ref.	13006012

Cupboards



Cupboards

Cupboards



Internal fittings

- Internal drawers and sliding shelves for individual division
- All drawers and sliding shelves are supplied with full extension slides and 40 mm overextension
- Heavy-duty drawer slide with 200 kg load capacity, standard-duty drawer slide with 75 kg load capacity
- cubio drawer dividers
- Galvanised shelves and base shelf inserts with a load capacity up to 160 kg

Box and case holders

- Organizer, the service cases for organising small parts
- Systainer³, the carry boxes for vehicles, assembly and workshops
- varioSlide, the pull-out and transport boxes
- bottBox, the standard materials box for assembly and logistics

Housing

- Load-bearing capacity up to max. 1.5 tonnes thanks to reinforced construction
- Various door options: hinged doors, hinged doors with inspection window, roller shutters, sliding doors
- Mechanical cabinet lock with 5-pin interchangeable cylinder for optional master/group locking systems

Accessories

- Drawer dividers
- Clothes rail
- 4-sided raised lip with non-slip mat
- Basic plinths
- Rear wall panels

Hinged door cupboards for cases



One system, one standard

- For use with the bott vario3 in-vehicle equipment as well as in the cubio workshop equipment. The cases, drawers and wire baskets can be stored safely and easily on the guide rails in the in-vehicle equipment and in the case hinged door cupboard. A glance at the cubio cupboard is sufficient to determine whether equipment has already been loaded into the service vehicle or is still in the workshop
- Empty cupboards can be subdivided to match individual requirements using comprehensive accessories.
 - Systainer³ + organizer system cases
 - varioCase service cases
 - varioSlide drawers
 - varioCart wire baskets



Typical applications

- For organised, secure storage of electric power tools, consumables and workshop tools.
- Can be used as a storage or magazine cabinet, (depending on the size). Suitable for cases of width M and L as well as varioSlide drawers and varioCart wire baskets of width 4 and 5.



Hinged door cupboards for cases

Width 938 mm



Dimensions W x D x H [mm]	938 x 400 x 2000	938 x 400 x 2000	938 x 400 x 2000
Order ref.	40032035.**V	40032036.**V	40032037.**V

Width 1050 mm



Dimensions W x D x H [mm]	1050 x 400 x 2000	1050 x 400 x 2000	1050 x 400 x 2000
Order ref.	40032038.**V	40032039.**V	40032040.**V

Shelves for hinged door cupboards for cases

Dimensions W x D x H [mm]	419 x 345 x 25	530 x 345 x 25	861 x 345 x 25	973 x 345 x 25
Order ref.	42101097.51V	42101098.51V	42101099.51V	42101100.51V

Housing: RAL 7035 – light grey	Top, base and fronts: Details on page 15 RAL 5010 – gentian blue RAL 7035 – light grey RAL 3004 – crimson red RAL 7016 – anthracite grey				ESD version available RAL 7035 – light grey	

Hinged door cupboards with bottBoxes

with 150 bottBoxes



- 2 hinged doors with perfo louvred form
- 2 rear walls with perfo louvred form H 350 mm
- 3 rear walls with perfo louvred form H 400 mm
- 6 bottBox M1 (W 130 x D 100 x H 65)
- 12 bottBox L3 (W 264 x D 298 x H 165)
- 18 bottBox M3 (W 130 x D 298 x H 165)
- 114 bottBox M2 (W 130 x D 198 x H 90)

Dimensions W x D x H [mm]	1050 x 650 x 2000
Version door	perfo louvred form
Order ref.	40021235.**V

with 52 bottBoxes and 3 drawers



- 2 hinged doors with perfo louvred form
- 2 shelves with usable depth 593 mm
- 1 base shelf infill
- 4 shelves with usable depth 343 mm
- 3 internal drawers H 125 mm
- 12 bottBox L5 (W 264 x D 498 x H 165)
- 16 bottBox L3 (W 264 x D 298 x H 165)
- 24 bott Box M2 (W 130 x D198 x H 90)

Dimensions W x D x H [mm]	1300 x 650 x 2000
Version door	perfo louvred form
Quantity of shelves	7
Order ref.	40022142.**V



Hinged door cupboards with bottBoxes

with 40 bottBoxes



- 2 hinged doors with perfo perforation
- 7 shelves
- 1 base shelf infill
- 8 bottBoxen M4 (W 130 x D 398 x H 165)
- 32 bottBoxen L4 (W 264 x D 398 x H 165)

Dimensions W x D x H [mm]	1300 x 525 x 2000
Version door	perfo
Quantity of shelves	8
Order ref.	40014071.**V

with 18 euroboxes



- 2 hinged doors with perfo perforation
- 5 shelves
- 1 base shelf infill
- 6 Euroboxes (W 600 x D 400 x H 120)
- 6 Euroboxes (W 600 x D 400 x H 220)
- 6 Euroboxes (W 600 x D 400 x H 320)

Dimensions W x D x H [mm]	1300 x 650 x 2000
Version door	perfo louvred form
Quantity of shelves	6
Order ref.	40022066.**V

Hinged door cupboards with internal drawers

with 4 internal drawers and worktop



- 2 hinged doors with perfo perforation
- 1 shelf
- 1 beech multiplex shelf (25 mm thick)
- 4 internal drawers H 125 mm

Dimensions W x D x H [mm]	1050 x 650 x 2000
Version door	perfo
Quantity of shelves	1
Order ref.	40021236.**V

with 2 internal drawers



- 2 hinged doors with perfo perforation
- 3 shelves
- 2 internal drawers H 125 mm

Dimensions W x D x H [mm]	1050 x 650 x 2000	1300 x 650 x 2000
Version door	perfo	perfo
Quantity of shelves	3	3
Order ref.	40021169.**V	40022139.**V



Hinged door cupboards with internal drawers

with 6 internal drawers



- 2 hinged doors with perfo perforation
- 2 shelves
- 3 internal drawers H 125 mm
- 3 Internal drawers H 175 mm

Dimensions W x D x H [mm]	1050 x 650 x 2000	1300 x 650 x 2000
Version door	perfo	perfo
Quantity of shelves	2	2
Order ref.	40021237.**V	40022141.**V

with 9 internal drawers



- 2 hinged doors with perfo perforation
- 3 shelves
- 9 internal drawers H 125 mm

Dimensions W x D x H [mm]	1050 x 650 x 2000	1300 x 650 x 2000
Version door	perfo	perfo
Quantity of shelves	3	3
Order ref.	40021238.**V	40022089.**V

Hinged door cupboards with internal drawers

with central dividing wall and 4 internal drawers



- 2 hinged doors with perfo perforation
- 1 central dividing wall
- 6 shelves
- 1 base shelf infill
- 4 Internal drawers H 175 mm
- with a cabinet width of 1050 mm - 4 x 525 mm
- with a cabinet width of 1300 mm - 4 x 650 mm
- with a cabinet width of 1600 mm - 4 x 800 mm

Dimensions W x D x H [mm]	1050 x 650 x 2000	1300 x 650 x 2000	1600 x 650 x 2000
Version door	perfo	perfo	perfo
Quantity of shelves	7	6	7
Order ref.	40021209.**V	40022099.**V	40023013.**V

Hinged doors with perfo louvred form



- Hinged doors with perfo louvred form for suspending bottBoxes and other small parts storage boxes
- 2 hinged doors
- 4 shelves

Dimensions W x D x H [mm]	1050 x 525 x 2000	1050 x 650 x 2000	1300 x 525 x 2000	1300 x 650 x 2000
Version door	perfo louvred form	perfo louvred form	perfo louvred form	perfo louvred form
Quantity of shelves	4	4	4	4
Order ref.	40013058.**V	40021126.**V	40014055.**V	40022056.**V



Hinged door cupboards

Hinged doors with Makrolon windows



- Hinged doors with makrolon windows make it possible to get an overview of the contents of the cupboard quickly without having to open it
- The cupboards with makrolon windows are not available as ESD version
- 2 hinged doors

Dimensions W x D x H [mm]	1050 x 525 x 1200	1050 x 650 x 1200	1050 x 525 x 2000	1050 x 650 x 2000
Version door	Makrolon windows	Makrolon windows	Makrolon windows	Makrolon windows
Quantity of shelves	3	3	4	4
Order ref.	40013061.**V	40021131.**V	40013064.**V	40021134.**V

Dimensions W x D x H [mm]	1300 x 650 x 1200	1300 x 525 x 1200	1300 x 650 x 2000	1300 x 525 x 2000
Version door	Makrolon windows	Makrolon windows	Makrolon windows	Makrolon windows
Quantity of shelves	3	3	4	4
Order ref.	40022058.**V	40014056.**V	40022060.**V	40014058.**V



	.11		.24	.19	.20 
Housing: RAL 7035 – light grey	Top, base and fronts: Details on page 15 RAL 5010 – gentian blue RAL 7035 – light grey	RAL 3004 – crimson red	RAL 7016 – anthracite grey	ESD version available RAL 7035 – light grey	

Hinged door cupboards with shelves

Hinged door cupboards with shelves

- Storage cupboard for universal use with large stowage volume
- Ergonomic access thanks to hinged doors with 180° opening angle
- Hinged doors with perfo perforation for attaching hooks and holders from the perfo product range
- Sturdy shelves made of zinc-plated sheet steel, load capacity up to 100 kg, from width 1300 mm up to 160 kg



Height 800 mm



Dimensions W x D x H [mm]	650 x 650 x 800	800 x 525 x 800	800 x 650 x 800	800 x 750 x 2000
Version door	perfo	perfo	perfo	perfo
Quantity of doors	1	2	2	2
Quantity of shelves	2	2	2	2
Order ref.	40019170.**V	40012121.**V	40020160.**V	40028099.**V



Dimensions W x D x H [mm]	1050 x 525 x 800	1050 x 650 x 800	1300 x 525 x 800	1300 x 650 x 800
Version door	perfo	perfo	perfo	perfo
Quantity of doors	2	2	2	2
Quantity of shelves	2	2	2	2
Order ref.	40013080.**V	40021239.**V	40014068.**V	40022145.**V



Hinged door cupboards with shelves

Height 900 mm



Dimensions W x D x H [mm]	650 x 650 x 900	800 x 525 x 900	800 x 650 x 900
Version door	perfo	perfo	perfo
Quantity of doors	1	2	2
Quantity of shelves	2	2	2
Order ref.	40019173.**V	40012124.**V	40020164.**V



Dimensions W x D x H [mm]	1050 x 525 x 900	1050 x 650 x 900	1300 x 525 x 900	1300 x 650 x 900
Version door	perfo	perfo	perfo	perfo
Quantity of doors	2	2	2	2
Quantity of shelves	2	2	2	2
Order ref.	40013084.**V	40021244.**V	40014072.**V	40022152.**V



Housing:

RAL 7035 – light grey

Top, base and fronts: Details on page 15

RAL 5010 – gentian blue

RAL 7035 – light grey

RAL 3004 – crimson red

RAL 7016 – anthracite grey

ESD version available

RAL 7035 – light grey

Hinged door cupboards with shelves

Height 1000 mm



Dimensions W x D x H [mm]	650 x 650 x 1000	800 x 525 x 1000	800 x 650 x 1000
Version door	perfo	perfo	perfo
Quantity of doors	1	2	2
Quantity of shelves	2	2	2
Order ref.	40019171.**V	40012122.**V	40020161.**V



Dimensions W x D x H [mm]	1050 x 525 x 1000	1050 x 650 x 1000
Version door	perfo	perfo
Quantity of doors	2	2
Quantity of shelves	2	2
Order ref.	40013081.**V	40021240.**V



Dimensions W x D x H [mm]	1300 x 525 x 1000	1300 x 650 x 1000
Version door	perfo	perfo
Quantity of doors	2	2
Quantity of shelves	2	2
Order ref.	40014069.**V	40022146.**V

Height 1200 mm



Dimensions W x D x H [mm]	1050 x 525 x 1200	1050 x 650 x 1200
Version door	perfo	perfo
Quantity of doors	2	2
Quantity of shelves	3	3
Order ref.	40013085.**V	40021245.**V



Hinged door cupboards with shelves

Height 1600 mm



Dimensions W x D x H [mm]	1050 x 525 x 1600	1050 x 650 x 1600
Version door	perfo	perfo
Quantity of doors	2	2
Quantity of shelves	3	3
Order ref.	40013086.**V	40021246.**V

Height 2000 mm



Dimensions W x D x H [mm]	800 x 525 x 2000	800 x 650 x 2000
Version door	perfo	perfo
Quantity of doors	2	2
Quantity of shelves	2	4
Order ref.	40012123.**V	40020162.**V



Dimensions W x D x H [mm]	1050 x 525 x 2000	1050 x 650 x 2000
Version door	perfo	perfo
Quantity of doors	2	2
Quantity of shelves	4	4
Order ref.	40013082.**V	40021241.**V



Dimensions W x D x H [mm]	1300 x 525 x 2000	1300 x 650 x 2000
Version door	perfo	perfo
Quantity of doors	2	2
Quantity of shelves	4	4
Order ref.	40014070.**V	40022147.**V

	.11	.16	.24	.19	.20
--	-----	-----	-----	-----	-----

Housing:

RAL 7035 – light grey

Top, base and fronts: Details on page 15

RAL 5010 – gentian blue

RAL 7035 – light grey

RAL 3004 – crimson red

RAL 7016 – anthracite grey

ESD version available

RAL 7035 – light grey

Wall cupboards

with hinged doors



- Robust and sturdy steel construction
- Rear panel with perforation or louvred form, depending on version
- Hinged doors, with perfo perforated lining
- Usable depth: 300mm



Version	empty	with shelf	with 40 piece hook kit
Rear panel	perfo	perfo	perfo
Dimensions W x D x H [mm]	1050 x 325 x 700	1050 x 325 x 700	1050 x 325 x 700
Order ref.	40031053.**V	40031054.**V	40031055.**V



Version	perfo	perfo
Rear panel	louvre	With perfo louvred form
Dimensions W x D x H [mm]	1050 x 325 x 700	1050 x 325 x 700
Order ref.	40031056.**V	40031070.**V



Wall cupboards

with lift up door



- The door is hinged upwards
- perfo louvred rear wall
- For mounting bottBoxes



Version	lift up	perfo	lift up
Rear panel	Louvre	Perfo	Perfo
Dimensions W x D x H [mm]	800 x 325 x 600	800 x 325 x 600	800 x 325 x 600
Order ref.	40031071.**V	40031075.**V	40031072.**V

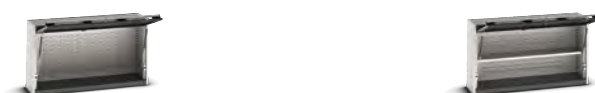

Version	lift up	lift up
Rear panel	Perfo	Perfo
Dimensions W x D x H [mm]	1050 x 325 x 600	1050 x 325 x 600
Order ref.	40031085.**V	40031086.**V

Shelves for suspended cabinets

Dimensions W x D x H [mm]	1042 x 233 x 20	792 x 233 x 20
For system width [mm]	1050	800
Order ref.	42101096.51	42101090.51

	.11		.24	.19		
Housing: RAL 7035 – light grey	Top, base and fronts: Details on page 15 RAL 5010 – gentian blue RAL 7035 – light grey RAL 3004 – crimson red RAL 7016 – anthracite grey				ESD version available RAL 7035 – light grey	

Roller shutter cupboards

Cupboards with plastic roller shutters



- High quality lock with interchangeable cylinder that can be replaced without tools
- Can be configured with shelves, sliding shelves, internal drawers, as well as an extensive range of bott cubio cupboard accessories
- Reduced-weight roller shutter – holds in every position
- Roller shutter winds onto a sprung shaft in the top of the cabinet when opened
- Smooth sliding thanks to aluminium guide rails
- Additional handle in the middle of the roller shutter – can be operated while standing
- Load capacity: up to 1.5 tonnes
- No obtrusive open doors swung open – requires little space

with shelves



- High-grade lock with interchangeable cylinder that can be replaced without tools
- Can be configured with shelves, sliding shelves, internal drawers, as well as an extensive range of bott cubio cupboard accessories
- Reduced-weight roller shutter – holds in every position
- Roller shutter winds onto a sprung shaft in the top of the cabinet when opened
- Smooth sliding thanks to aluminium guide rails
- Additional handle in the middle of the roller shutter – can be operated while standing
- Load capacity: up to 1.5 tonnes
- No obtrusive open doors swung open – requires little space

Dimensions W x D x H [mm]	1050 x 650 x 2000	1300 x 650 x 2000
Version door	Roller shutter	Roller shutter
Quantity of doors	1	1
Quantity of shelves	4	4
Order ref.	40201011.**V	40201013.**V



Roller shutter cupboards



Sliding door cupboards

Cupboards with sliding doors



- High quality lock with interchangeable cylinder that can be replaced without tools
- Can be configured with shelves, sliding shelves, internal drawers, as well as an extensive range of bott cubio cupboard accessories
- The sliding doors are equipped with carriers – thus allowing both doors to be moved simultaneously
- Quiet closing due to soft impact dampers on the sliding doors
- Doors do not impede the aisles when open
- Little space required in front of the cabinet
- Load capacity up to 1.5 tonnes
- Very high storage space with maximum usable volume
- Central open frame divider
- Variant with central dividing wall is suitable for assembly with sliding shelves, individual drawers and shelves

with shelves and central dividing wall



- 2 sliding doors
- 2 shelves

Dimensions W x D x H [mm]	1050 x 650 x 1000	1300 x 650 x 1000
Order ref.	40021138.**V	40022062.**V



Sliding door cupboards

with shelves and central dividing wall



- 2 sliding doors
- 4 shelves

Dimensions W x D x H [mm]	1050 x 650 x 2000	1300 x 650 x 2000
Order ref.	40021141.**V	40022065.**V

with shelves and central dividing wall



- 2 sliding doors
- 1 central dividing wall
- 1 base shelf infill
- 6 shelves
- system width 2x 800 mm

Dimensions W x D x H [mm]	1600 x 650 x 2000
Order ref.	40023008.**V

	.11	.16	.24	.19		.20
Housing: RAL 7035 – light grey	Top, base and fronts: Details on page 15 RAL 5010 – gentian blue RAL 7035 – light grey RAL 3004 – crimson red RAL 7016 – anthracite grey				ESD version available RAL 7035 – light grey	

Sliding door cupboards

with shelves and central dividing wall



- 2 sliding doors
- 1 central dividing wall
- 1 base shelf infill
- 8 shelves
- system width 2x 800 mm

Dimensions W x D x H [mm]

1600 x 650 x 2000

Order ref.

40023009.V**

with internal drawers and central dividing wall



- 2 sliding doors
- 4 internal drawers with front height 125 mm
- 1 central dividing wall
- 1 base shelf infill
- 6 shelves
- system width 2x 800 mm

Dimensions W x D x H [mm]

1600 x 650 x 2000

Order ref.

40023015.V**



Vertical pull-out panel cupboards

Height 2000 mm



- With 2 or 4 vertical pull-out panels fitted on both sides with perfo perforations
- Perfect organisation and clear arrangement
- Large perfo surface with minimum space required
- Maximum load: 120 kg per vertical pull-out panel
- For safe storage of heavy loads
- Full extension heavy duty slides for comfortable access
- Each pull-out panel has an ergonomic, integral handle
- Standard blocking mechanism - only one 1 vertical pull-out panel can be pulled out at a time to ensure stability
- Optional hinged doors or hinged doors with Makrolon windows
- Version with Makrolon windows is not available as ESD version

Door design	perfo			
Dimensions W x D x H [mm]	1050 x 650 x 2000		1300 x 650 x 2000	
Order ref.	40301007.**V	40301050.**V	40301019.**V	40301023.**V

Door design	Makrolon windows			
Dimensions W x D x H [mm]	1050 x 650 x 2000		1300 x 650 x 2000	
Order ref.	40301008.**V	40301051.**V	40301020.**V	40301024.**V

	.11	.16	.24	.19		.20
Housing: RAL 7035 – light grey	Top, base and fronts: Details on page 15 RAL 5010 – gentian blue RAL 7035 – light grey RAL 3004 – crimson red RAL 7016 – anthracite grey				ESD version available RAL 7035 – light grey	

Battery charging cupboard

Battery charging cupboard



- For the central charging and storage of battery-operated tools
- A secure 3-point lock protects from unauthorised access and theft
- Central power supply via socket strip with On/Off switch, RCD and circuit breakers
- 2 perforated shelves with integrated multiple sockets and cable tray for charging batteries
- Cable tray for concealing power leads
- 2 normal shelves for storing electric devices and accessories
- Up to 18 sockets (230V) for battery charges (depending on the charger variant)
- Active ventilation through heavy-duty axial fan with filter mat
- Overpressure mode protects from dust formation inside the cabinet
- Optional 230V or 400V connection cable available as an accessory
- The cabinet is pre-assembled and ready for connection, the on-site cable installation is carried out by the client. A suitable connector plug (GST18 230V/16A, 3-pole or 400V / 16 A, 5-pole) is included

Dimensions W x D x H [mm]	1050 x 400 x 2000	1050 x 400 x 2000	1050 x 400 x 2000	1050 x 400 x 2000
Power supply	230 Volt	230 Volt	230 Volt	230 Volt
For plug system	DE (Schuko / Typ F)	CH (Typ J)	FR (Typ E)	DK (Typ K)
Quantity of sockets in total	16	18	18	18
Order ref.	40032031.**V	40032032.**V	40032033.**V	40032034.**V

Dimensions W x D x H [mm]	1050 x 400 x 2000	1050 x 400 x 2000	1050 x 400 x 2000	1050 x 400 x 2000
Power supply	400 Volt	400 Volt	400 Volt	400 Volt
For plug system	DE (Schuko / Typ F)	CH (Typ J)	FR (Typ E)	DK (Typ K)
Quantity of sockets in total	16	18	18	18
Order ref.	40032027.**V	40032028.**V	40032029.**V	40032030.**V

suitable connection cables

Version	Schuko plug, GST18 socket, 230V / 16 A, 3-pin	Schuko plug, GST18 socket, 230V / 16 A, 3-pin	CEE plug, GST18 socket, 400V / 16 A, 5-pin	CEE plug, GST18 socket, 400V / 16 A, 5-pin
Length [m]	3	5	3	5
Order ref.	43503001	43503002	43503005	43503006

Version	CH plug Type 25, GST18 socket, 230V / 16 A, 3-pin	CH plug Type 25, GST18 socket, 230V / 16 A, 3-pin	CH plug Type 25, GST18 socket, 400V / 16 A, 5-pin	CH plug Type 25, GST18 socket, 400V / 16 A, 5-pin
Length [m]	3	5	3	5
Order ref.	43503012	43503013	43503016	43503017



Battery charging cupboard



Housing:

RAL 7035 – light grey

Top, base and fronts: Details on page 15

RAL 5010 – gentian blue

RAL 7035 – light grey

RAL 3004 – crimson red

RAL 7016 – anthracite grey

ESD version available

RAL 7035 – light grey

Accessories for cupboards

Clothes rail



- Insertable in the side pieces via holders
- Height-adjustable in increments of 25 mm
- Depth-adjustable in increments of 100 mm
- Clothes hangers can be used in cabinet depths of 650 mm and above
- Set includes 6 hooks
- Colours: Bar: Anodised aluminium hooks: Galvanised steel

For system width [mm]	1050		1300	
For system depth [mm]	525	650	525	650
Order ref.	41010045.16V	41010046.16V	41010049.16V	41010050.16V

Drawer cabinet and cupboard accessories



Accessories for cupboards

Rear wall panel with perfo perforation

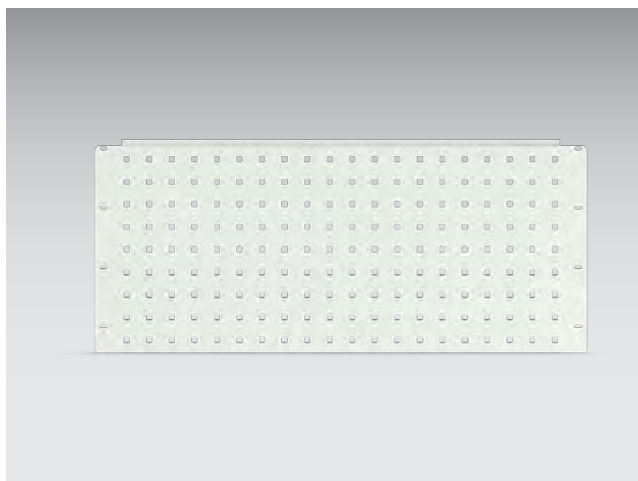

- For mounting perfo hooks & holders
- Can be mounted behind shelf, internal drawer, beech multiplex insert shelf and sliding shelf
- Max. usable installation height = housing height - 100 mm
- Mounting of individual perfo perforated panels also possible
- Colour: light grey (RAL 7035)

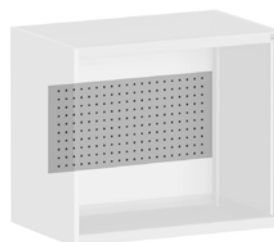

For system width [mm]	1050	1050	1050	1300	1300	1300
Panel height [mm]	350	400	450	350	400	450
Order ref.	43005004.16M	43005005.16M	43005006.16M	43005007.16M	43005008.16M	43005009.16M

Perfo rear wall panels with perfo louvred form

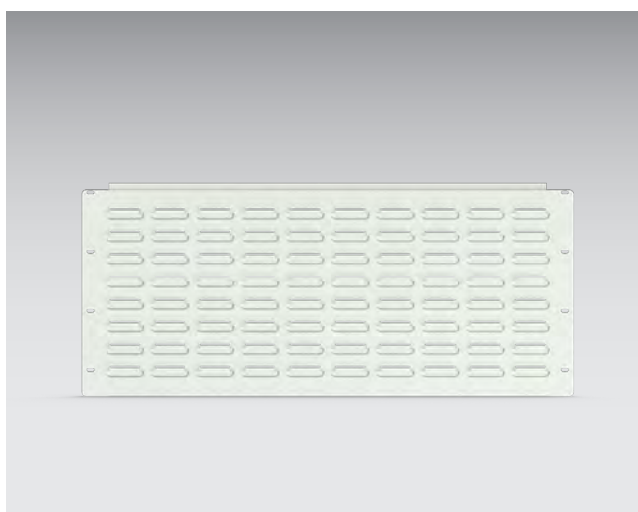

- For mounting bottBoxes and plastic bins
- Shelves can only be inserted in front of the rear wall panels where two rear wall panels meet.
- Cannot be mounted behind internal drawer or beech multiplex internal shelf
- Max. usable installation height = housing height - 100 mm
- Mounting of individual perfo louvred panels also possible
- Colour: light grey (RAL 7035)

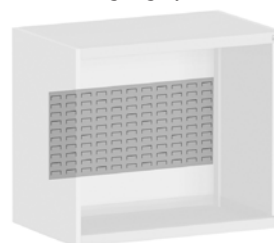

For system width [mm]	1050	1050	1300	1300
Panel height [mm]	350	400	350	400
Order ref.	43005013.16M	43005014.16M	43005016.16M	43005017.16M

Accessories for drawer cabinets

Individual drawer locks



- Lock individual drawers as extra security for the central locking mechanism
- Ideal for training workshops, to store high value tools or personal utensils
- Interchangeable cylinder, allows each drawer to be keyed differently
- Master locking system optional



Order ref.

12602048.10M

Access protection for drawers with individual drawer locks



- Closing panels between drawer levels prevent access through an open drawer to the contents of a locked drawer below
- Only available for drawer heights 100 mm and greater



System dimensions W x D [mm]

525 x 525

525 x 650

650 x 650

Order ref.

42104003.51M

42104004.51M

42104007.51M

Accessories for drawer cabinets and cupboards

Keys and locks for mechanical locking systems



- Please specify lock number
- Material: Brass, bright nickel-coated



Version	Spare key	Cylinder removal key	Interchangeable cylinder incl. 2 keys
Order ref.	12603016.51V	12603018.51V	12602039.51V



Accessories for drawer cabinets and cupboards

Base shelf infills



- For insertion in the housing floor
- Flat surface for easy loading and unloading
- Height: 64 mm
- Surface: galvanised

For system width [mm]	525	525	650	650
For system depth [mm]	525	650	525	650
Order ref.	42101030.51M	42101031.51M	42101034.51M	42101035.51M

For system width [mm]	800	800	800
For system depth [mm]	525	650	750
Order ref.	42101038.51M	42101039.51M	42101040.51M

For system width [mm]	1050	1050	1300	1300
For system depth [mm]	650	750	650	750
Order ref.	42101043.51M	42101044.51M	42101047.51M	42101048.51M



Accessories for drawer cabinets and cupboards

Shelves



- Two support brackets for mounting in 25 mm increments
- Load bearing capacity: 100 kg, from width 1300 mm 160 kg
- Surface: galvanised

For system width [mm]	525	525	650	650
For system depth [mm]	525	650	525	650
Order ref.	42101006.51M	42101007.51M	42101010.51M	42101011.51M

For system width [mm]	800	800	800
For system depth [mm]	525	650	750
Order ref.	42101014.51M	42101015.51M	42101016.51M

For system width [mm]	1050	1050	1300	1300
For system depth [mm]	650	750	650	750
Order ref.	42101019.51M	42101020.51M	42101023.51M	42101024.51M

Accessories for drawer cabinets and cupboards

Sliding shelves

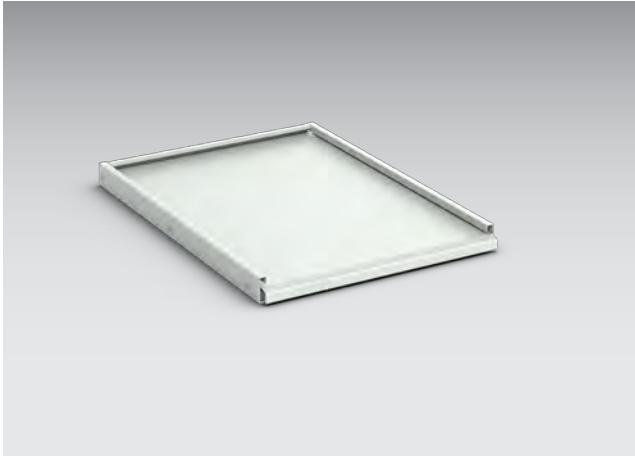

- With 3 sided safety lip
- For a system depth of 650 mm
- Height-adjustable in increments of 25 mm
- Standard duty slides 75 kg load capacity, full extension
- Heavy duty slides 200 kg load capacity, full extension
- Colour: light grey (RAL 7035)



For system width [mm]	525	650	800	800
Height [mm]	50	50	50	75
Order ref.	40522083.16M	40522085.16M	40522087.16M	40522088.16M

For system width [mm]	1050	1050	1300	1300
Height [mm]	50	75	50	75
Order ref.	40522089.16M	40522090.16M	40522091.16M	40522092.16M

Accessories for drawer cabinets and cupboards

Internal drawers

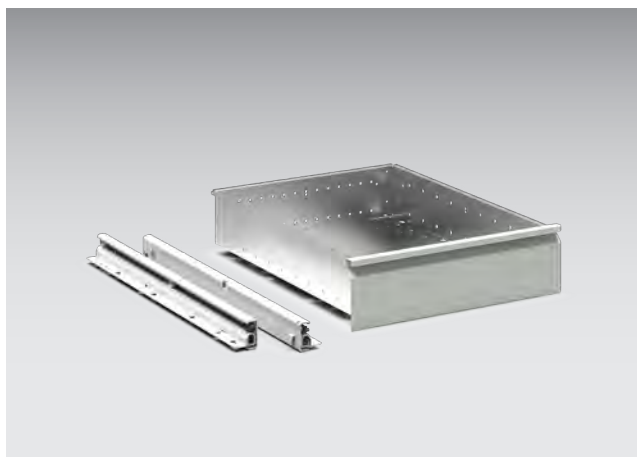

- Drawer for customising an empty housing
- For system width 650 mm
- Standard duty slides 75 kg load capacity, full extension
- Heavy duty slides 200 kg load capacity, full extension
- Colour: light grey (RAL 7035)



For system width [mm]	525	525	650	650
version	Standard duty	Standard duty	Standard duty	Standard duty
Height [mm]	125	175	125	175
Order ref.	40522029.16M	40522031.16M	40522033.16M	40522035.16M

For system width [mm]	800	800	800	800
version	Standard duty	Heavy duty	Standard duty	Heavy duty
Height [mm]	125	125	175	175
Order ref.	40522037.16M	40522038.16M	40522039.16M	40522040.16M

For system width [mm]	1050	1050	1050	1050
version	Standard duty	Heavy duty	Standard duty	Heavy duty
Height [mm]	125	125	175	175
Order ref.	40522041.16M	40522042.16M	40522043.16M	40522044.16M

For system width [mm]	1300	1300	1300	1300
version	Standard duty	Heavy duty	Standard duty	Heavy duty
Height [mm]	125	125	175	175
Order ref.	40522045.16M	40522046.16M	40522047.16M	40522048.16M

Accessories for drawer cabinets and cupboards

Cabinet cover with 4-sided anti roll-off lip

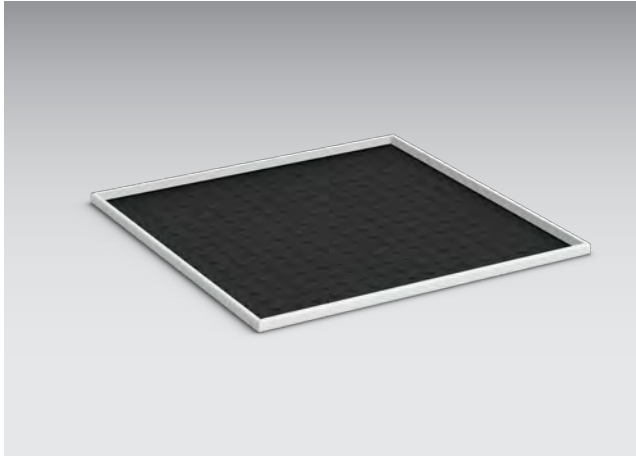

- For mounting on housing top
- Fitted slip-resistant plastic mat
- Height: 15 mm
- Tray colour: light grey (RAL 7035) Mat: black



For system width [mm]	525	525	650
For system depth [mm]	525	650	650
Order ref.	42102005.16M	42102006.16M	42102008.16M

For system width [mm]	800	800	800
For system depth [mm]	525	650	750
Order ref.	42102011.16M	42102012.16M	42102013.16M

For system width [mm]	1050	1050	1050
For system depth [mm]	525	650	750
Order ref.	42102015.16M	42102016.16M	42102017.16M

For system width [mm]	1300	1300	1300
For system depth [mm]	525	650	750
Order ref.	42102019.16M	42102020.16M	42102021.16M

Accessories for drawer cabinets and cupboards

Forklift base

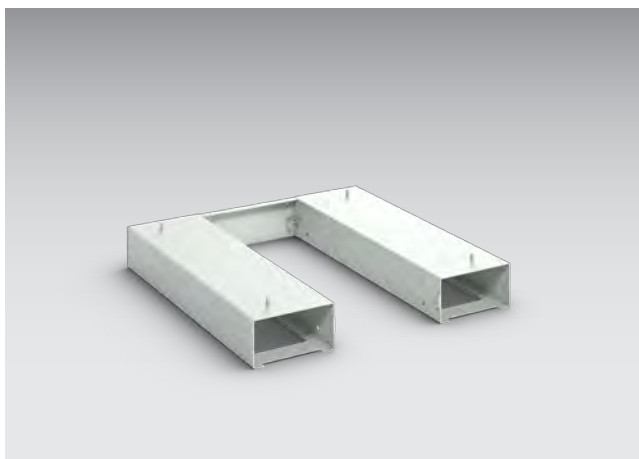

- 2 cross members for mounting to housing base
- With removable front panel
- Height: 100 mm
- Load capacity: 1 tonne
- Colour: light grey (RAL 7035)



For system width [mm]	650	800	800	800
For system depth [mm]	650	525	650	750
Order ref.	41430008.16M	41430005.16M	41430009.16M	41430013.16M

For system width [mm]	1050	1050	1050
For system depth [mm]	525	650	750
Order ref.	41430006.16M	41430010.16M	41430014.16M

For system width [mm]	1300	1300	1300
For system depth [mm]	525	650	750
Order ref.	41430007.16M	41430011.16M	41430015.16M

Plinth cover panel for forklift base



- Height: 100 mm
- Colour: light grey

For system width [mm]	650	800	1050	1300
Order ref.	41430132.16V	41430133.16V	41430134.16V	41430135.16V

Accessories for drawer cabinets and cupboards

Height adjustable plinth



- 4 cross members for mounting to housing base
- Standard height: 50 mm
- 4 adjustable feet with an adjustment range from 0 to +40 mm
- Floor fixing possible
- Load capacity: 1 tonne
- Colour: black-grey

For system width [mm]	525		650	
For system depth [mm]	525	650	525	650
Order ref.	41430086.70M	41430087.70M	41430089.70M	41430090.70M

For system width [mm]	800		
For system depth [mm]	525	650	750
Order ref.	41430092.70M	41430093.70M	41430094.70M

For system width [mm]	1050			
For system depth [mm]	400	525	650	750
Order ref.	41430095.70M	41430096.70M	41430097.70M	41430098.70M

For system width [mm]	1300			1600
For system depth [mm]	525	650	750	650
Order ref.	41430099.70M	41430100.70M	41430101.70M	41430103.70M

Accessories for drawer cabinets and cupboards

Base with floor seal



- 4 cross members for mounting to housing base (floor seal included)
- Standard height: 50 mm
- 4 adjustable feet with an adjustment range from 0 to +20 mm
- Floor fixing possible
- Load capacity: 1 tonne
- Colour: black-grey



For system width [mm]	525		650	
For system depth [mm]	525	650	525	650
Order ref.	41430107.70M	41430108.70M	41430110.70M	41430111.70M

For system width [mm]	800		
For system depth [mm]	525	650	750
Order ref.	41430113.70M	41430114.70M	41430115.70M

For system width [mm]	1050		
For system depth [mm]	525	650	750
Order ref.	41430116.70M	41430117.70M	41430118.70M

For system width [mm]	1300		1600	
For system depth [mm]	525	650	750	650
Order ref.	41430120.70M	41430121.70M	41430122.70M	41430124.70M

Storage benches

Framework and storage workbenches



Storage benches



Rear frame for worktops

- Modular system frame with versatile avevo accessories
- perfo rear panel for the provision of materials and tools



Components

- Base frame available in static and mobile versions
- Uniform working height for static and mobile versions
- Optional height adjustment for adjusting to work processes
- Solid red beech or multiplex beech worktop with oiled surface – thickness 40 mm
- Load capacity up to max. 1.2 tonnes
- Delivered in a pre-assembled condition



Drawers

- All drawers supplied with full extension slides and 40 mm over extension
- Standard-duty drawer slides with 75 kg load capacity
- Ergonomic bow handle with access from above and below
- Shelves and pull-out trays for versions with hinged door



Accessories

- perfo end panel
- Brush matting for the work surface
- Worktop upstand

Storage benches

Width 1500 mm



- 3 Drawers with standard duty slide (W 1350 x D 650 mm)

Dimensions W x D x H [mm]	1500 x 750 x 840	1500 x 750 x 840
Quantity of drawers/doors	3	3
Front height [mm]	2x150, 1x200	2x150, 1x200
Load capacity [kg]	1200	800
Worktop	Red beech	Beech Multiplex
Order ref.	41002168.**V	41002169.**V

Width 1500 mm



- 3 Drawers with standard duty slide (W 650 x D 650 mm)
- 1 Hinged door, height 500 mm
- 1 Shelf

Dimensions W x D x H [mm]	1500 x 750 x 840	1500 x 750 x 840
Quantity of drawers/doors	3, 1	3, 1
Front height [mm]	2x150, 1x200	2x150, 1x200
Load capacity [kg]	1200	800
Worktop	Red beech	Beech Multiplex
Order ref.	41002026.**V	41002025.**V



Storage benches

Width 1500 mm



- 6 drawers with standard duty slide (W 650 x D 650 mm)

Dimensions W x D x H [mm]	1500 x 750 x 840	1500 x 750 x 840
Quantity of drawers/doors	6	6
Front height [mm]	4x150, 2x200	4x150, 2x200
Load capacity [kg]	1200	800
Worktop	Red beech	Beech Multiplex
Order ref.	41002032.**V	41002031.**V

Width 1500 mm



- 2 drawers with standard duty slide (W 650 x D 650 mm)
- 2 hinged doors, height 350 mm

Dimensions W x D x H [mm]	1500 x 750 x 840	1500 x 750 x 840
Quantity of drawers/doors	2, 2	2, 2
Front height [mm]	2x150	2x150
Load capacity [kg]	1200	800
Worktop	Red beech	Beech Multiplex
Order ref.	41002029.**V	41002028.**V



Housing: RAL 7035 – light grey **Top, base and fronts:** Details on page 15
 RAL 5010 – gentian blue RAL 7035 – light grey RAL 3004 – crimson red RAL 7016 – anthracite grey

Storage benches

Width 1500 mm



- 2 hinged doors, height 500 mm
- 2 shelves

Dimensions W x D x H [mm]	1500 x 750 x 840	1500 x 750 x 840
Quantity of drawers/doors	2	2
Front height [mm]	2x500	2x500
Load capacity [kg]	1200	800
Worktop	Red beech	Beech Multiplex
Order ref.	41002023.**V	41002022.**V

Width 1500 mm



- 3 drawers with standard duty slide (W 650 x D 650 mm)
- 1 recessed base

Dimensions W x D x H [mm]	1500 x 750 x 840	1500 x 750 x 840
Quantity of drawers/doors	3	3
Front height [mm]	2x150, 1x200	2x150, 1x200
Load capacity [kg]	1200	800
Worktop	Red beech	Beech Multiplex
Order ref.	41002041.**V	41002040.**V



Storage benches

Width 1500 mm



- 3 drawers with standard duty slide (W 650 x D 650 mm)
- 1 shelf

Dimensions W x D x H [mm]	1500 x 750 x 840	1500 x 750 x 840
Quantity of drawers/doors	3	3
Front height [mm]	2x150, 1x200	2x150, 1x200
Load capacity [kg]	1200	800
Worktop	Red beech	Beech Multiplex
Order ref.	41002188.**V	41002166.**V

Width 2000 mm



- 6 drawers with standard duty slide (W 650 x D 650 mm)
- 1 recessed base

Dimensions W x D x H [mm]	2000 x 750 x 840	2000 x 750 x 840
Quantity of drawers/doors	6	6
Front height [mm]	4x150, 2x200	4x150, 2x200
Load capacity [kg]	1000	600
Worktop	Red beech	Beech Multiplex
Order ref.	41002074.**V	41002073.**V



Housing:

RAL 7035 – light grey

Top, base and fronts: Details on page 15

RAL 5010 – gentian blue

RAL 7035 – light grey

RAL 3004 – crimson red

RAL 7016 – anthracite grey

Storage benches

Width 2000 mm



- 3 drawers with standard duty slide (W 650 x D 650 mm)
- 1 hinged door, height 500 mm > 1 recessed base

Dimensions W x D x H [mm]	2000 x 750 x 840	2000 x 750 x 840
Quantity of drawers/doors	3, 1	3, 1
Front height [mm]	2x150, 1x200	2x150, 1x200
Load capacity [kg]	1000	600
Worktop	Red beech	Beech Multiplex
Order ref.	41002071.**V	41002070.**V

Width 2000 mm



- 3 Drawers with standard duty slide (W 650 x D 650 mm)
- 2 Hinged doors, height 500 mm
- 2 Shelves

Dimensions W x D x H [mm]	2000 x 750 x 840	2000 x 750 x 840
Quantity of drawers/doors	3, 2	3, 2
Front height [mm]	2x150, 1x200	2x150, 1x200
Load capacity [kg]	1000	600
Worktop	Red beech	Beech Multiplex
Order ref.	41002056.**V	41002055.**V



Framework and storage bench accessories from page 156

Storage benches

Width 2000 mm



- 4 drawers with standard-duty drawer slide (W 650 x D 650 mm)
- 1 hinged door, height 350 mm
- 1 shelf

Dimensions W x D x H [mm]	2000 x 750 x 840	2000 x 750 x 840
Quantity of drawers/doors	4, 1	4, 1
Front height [mm]	3x150, 1x200	3x150, 1x200
Load capacity [kg]	1000	600
Worktop	Red beech	Beech Multiplex
Order ref.	41002059.**V	41002058.**V

Width 2000 mm



- 5 Drawers with standard duty slide (W 650 x D 650 mm)
- 2 Hinged doors, height 350 mm

Dimensions W x D x H [mm]	2000 x 750 x 840	2000 x 750 x 840
Quantity of drawers/doors	5, 2	5, 2
Front height [mm]	4x150, 1x200, 2x350	4x150, 1x200
Load capacity [kg]	1000	600
Worktop	Red beech	Beech Multiplex
Order ref.	41002065.**V	41002064.**V



Housing:

RAL 7035 – light grey

Top, base and fronts: Details on page 15

RAL 5010 – gentian blue

RAL 7035 – light grey

RAL 3004 – crimson red

RAL 7016 – anthracite grey

Storage benches

Width 2000 mm



- 2 hinged doors, height 500 mm
- 3 shelves

Dimensions W x D x H [mm]	2000 x 750 x 840	2000 x 750 x 840
Quantity of drawers/doors	2	2
Load capacity [kg]	1000	600
Worktop	Red beech	Beech Multiplex
Order ref.	41002050.**V	41002049.**V

Framework and storage workbenches

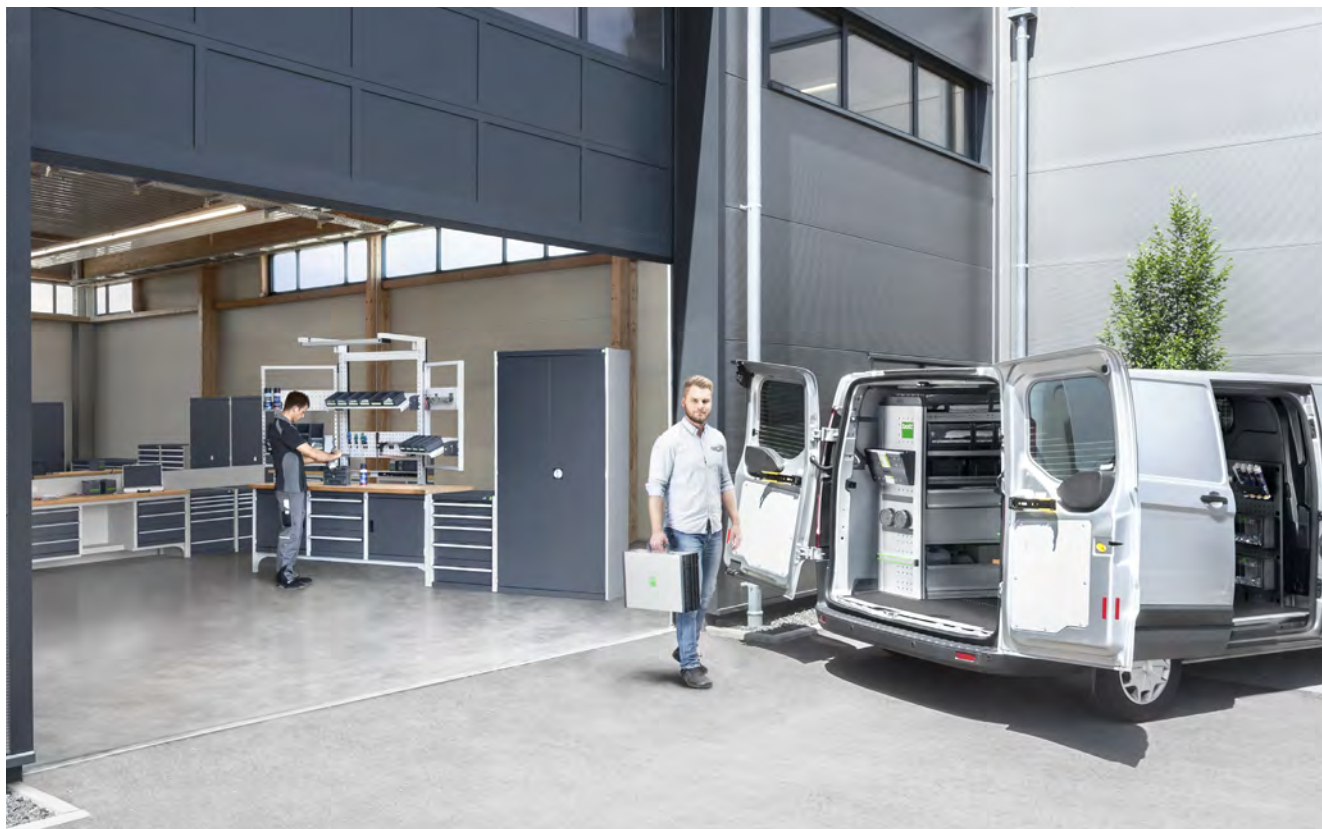

Mobile storage benches

Width 1500 mm



- 3 drawers with standard-duty drawer slide (W 650 x D 650 mm)
- 1 hinged door, height 500 mm
- 1 shelf
- 4 swivel castors with brake

Dimensions W x D x H [mm]	1500 x 750 x 840	1500 x 750 x 840
Quantity of drawers/doors	3, 1	3, 1
Front height [mm]	2x150, 1x200	2x150, 1x200
Load capacity [kg]	300	300
Worktop	Red beech	Beech Multiplex
Order ref.	41002101.**V	41002100.**V

Width 1500 mm



- 6 drawers with standard-duty drawer slide (W 650 x D 650 mm)
- 4 swivel castors with brake

Dimensions W x D x H [mm]	1500 x 750 x 840	1500 x 750 x 840
Quantity of drawers/doors	6	6
Front height [mm]	4x150, 2x200	4x150, 2x200
Load capacity [kg]	300	300
Worktop	Red beech	Beech Multiplex
Order ref.	41002107.**V	41002106.**V



Housing:

RAL 7035 – light grey

Top, base and fronts: Details on page 15

RAL 5010 – gentian blue

RAL 7035 – light grey

RAL 3004 – crimson red

RAL 7016 – anthracite grey

Mobile storage benches

Width 1500 mm



- 1 hinged door, height 500 mm
- 2 shelves
- 4 swivel castors with brake

Dimensions W x D x H [mm]	1500 x 750 x 840	1500 x 750 x 840
Quantity of drawers/doors	1	1
Front height [mm]	1x500	1x500
Load capacity [kg]	300	300
Worktop	Red beech	Beech Multiplex
Order ref.	41002095.**V	41002094.**V

Width 1500 mm



- 2 hinged doors, height 500 mm
- 2 shelves
- 4 swivel castors with brake

Dimensions W x D x H [mm]	1500 x 750 x 840	1500 x 750 x 840
Quantity of drawers/doors	2	2
Front height [mm]	2x500	2x500
Load capacity [kg]	300	300
Worktop	Red beech	Beech Multiplex
Order ref.	41002098.**V	41002097.**V



Mobile storage benches

Width 1500 mm



- 2 drawers with standard duty slide (W 650 x D 650 mm)
- 2 hinged doors, height 350 mm
- 4 swivel castors with brake

Dimensions W x D x H [mm]	1500 x 750 x 840	1500 x 750 x 840
Quantity of drawers/doors	2, 2	2, 2
Front height [mm]	2x150, 2x350	2x150, 2x350
Load capacity [kg]	300	300
Worktop	Red beech	Beech Multiplex
Order ref.	41002104.**V	41002103.**V

Width 1500 mm



- 3 drawers with standard duty slide (W 650 x D 650 mm)
- 1 recessed base
- 4 swivel castors with brake

Dimensions W x D x H [mm]	1500 x 750 x 840	1500 x 750 x 840
Quantity of drawers/doors	2	3
Front height [mm]	2x150, 1x200	2x150, 1x200
Load capacity [kg]	300	300
Worktop	Red beech	Beech Multiplex
Order ref.	41002116.**V	41002115.**V



Housing:

RAL 7035 – light grey

Top, base and fronts: Details on page 15

RAL 5010 – gentian blue

RAL 7035 – light grey

RAL 3004 – crimson red

RAL 7016 – anthracite grey

Mobile storage benches

Width 2000 mm



- 5 drawers with standard-duty drawer slide (W 650 x D 650 mm)
- 2 hinged doors, height 350 mm
- 4 swivel castors with brake

Dimensions W x D x H [mm]	2000 x 750 x 840	2000 x 750 x 840
Quantity of drawers/doors	5, 2	5, 2
Front height [mm]	4x150, 1x200	4x150, 1x200
Load capacity [kg]	300	300
Worktop	Red beech	Beech Multiplex
Order ref.	41002134.**V	41002133.**V

Width 2000 mm



- 3 drawers with standard-duty drawer slide (W 650 x D 650 mm)
- 2 hinged doors, height 500 mm
- 2 shelves
- 4 swivel castors with brake

Dimensions W x D x H [mm]	2000 x 750 x 840	2000 x 750 x 840
Quantity of drawers/doors	3, 2	3, 2
Front height [mm]	2x150, 1x200	2x150, 1x200
Load capacity [kg]	300	300
Worktop	Red beech	Beech Multiplex
Order ref.	41002125.**V	41002124.**V



Framework and storage bench accessories from page 156

Mobile storage benches

Width 2000 mm



- 2 hinged doors, height 500 mm
- 3 shelves
- 4 swivel castors with brake

Dimensions W x D x H [mm]	2000 x 750 x 840	2000 x 750 x 840
Quantity of drawers/doors	2	2
Front height [mm]	2x500	2x500
Load capacity [kg]	300	300
Worktop	Beech Multiplex	Beech Multiplex
Order ref.	41002119.**V	41002118.**V

Width 2000 mm



- 6 drawers with standard duty slide (W 650 x D 650 mm)
- 1 shelf
- 4 swivel castors with brake

Dimensions W x D x H [mm]	2000 x 750 x 840	2000 x 750 x 840
Quantity of drawers/doors	6	6
Front height [mm]	4x150, 2x200	4x150, 2x200
Load capacity [kg]	300	300
Worktop	Red beech	Beech Multiplex
Order ref.	41002131.**V	41002130.**V



Housing:

RAL 7035 – light grey

Top, base and fronts: Details on page 15

RAL 5010 – gentian blue

RAL 7035 – light grey

RAL 3004 – crimson red

RAL 7016 – anthracite grey

Framework benches

Framework and storage workbenches



Framework benches



Rear panel systems

- Modular system frame with versatile avero accessories
- perfo rear panel for the provision of materials and tools



Hexagonal worktop

- Ideal for training workshops and schools
- Expandable with power and compressed air supply



Accessories

- perfo panels, perfo back walls
- Base storage trays
- Brush matting
- Worktop upstands



Components

- Modular system for layout of workbenches individually or in rows
- Load capacity up to max. 2.0 tonnes (all load specifications only valid with addition workbench legs screwed in place)
- Solid red beech or beech multiplex worktop, thickness 40 mm
- Height-adjustable and mobile workbench legs



Drawers

- All drawers supplied with full extension slides and 40 mm over extension
- Standard duty slide with 75 kg load capacity
- Heavy duty slide with 200 kg load capacity
- Ergonomic bow handle with access from above and below
- Shelves and sliding shelves for pedestal cabinets with hinged door

Framework benches

Workbench package with mounting frame and 2 swivel frames



- Framework bench 2000 x 750 mm
- Height adjustable legs
- Beech multiplex worktop
- Central mounting frame, width 900 mm, with: perfo perforated panel, shelf tray with 6x bottBox M3, overhead arm with LED strip light LB (30/40/50W)
- Side swivel frame with: 2x shelf trays with 4x bottBox M3, 2x perfo perforated panels
- Optional version with drawer cabinet



- For configurations with strip lights, a compatible GST-18 connection cable is also required

Dimensions W x D [mm]	2000 x 750	2000 x 750
Work height table top from - to [mm]	740-1140	740-1140
total height from - to [mm]	2.097 - 2.497	2.097 - 2.497
Version	Without drawer cabinet	With drawer cabinet
Quantity of drawers		1845
Front height [mm]		2x150
Stringers bottom	Yes	Yes
Load capacity [kg]	600	600
Worktops	Beech Multiplex	Beech Multiplex
Order ref.	41003558.16V	41003563.16V



Framework benches

Workbench package with mounting frame



- Framework bench 2000 x 750 mm
- Height-adjustable legs
- Beech multiplex worktop
- Central rear frame, width 1800 mm, with: perforated panel, bin rail with 13x bottBox M3
- Optional design with drawer cabinet



Dimensions W x D [mm]	2000 x 750	2000 x 750
Work height table top from - to [mm]	740-1140	740-1140
total height from - to [mm]	2.097 - 2.497	2.097 - 2.497
Version	Without drawer cabinet	With drawer cabinet
Quantity of drawers		1845
Front height [mm]		2x150
Stringers bottom	Yes	Yes
Load capacity [kg]	600	600
Worktops	Beech Multiplex	Beech Multiplex
Order ref.	41003556.16V	41003561.16V



	.11			.24	.19
Housing:	Top, base and fronts: Details on page 15				
RAL 7035 – light grey	RAL 5010 – gentian blue	RAL 7035 – light grey	RAL 3004 – crimson red	RAL 7016 – anthracite grey	

Framework benches

Workbench package with mounting frame and swivel frame



- Framework bench 2000 x 750 mm
- Height-adjustable legs
- Beech multiplex worktop
- Rear frame, width 1350 mm, with: perfo perforated panel, bin rail with 10x bottBox M3
- Side swivel frame with: shelves with 4x bottBox M3 perfo perforated panels
- Optional design with drawer cabinet



Dimensions W x D [mm]	2000 x 750	2000 x 750
Work height table top from - to [mm]	740-1140	740-1140
total height from - to [mm]	2.097 - 2.497	2.097 - 2.497
Version	Without drawer cabinet	With drawer cabinet
Quantity of drawers		1845
Front height [mm]		2x150
Stringers bottom	Yes	Yes
Load capacity [kg]	600	600
Worktops	Beech Multiplex	Beech Multiplex
Order ref.	41003557.16V	41003562.16V



Framework benches

Workbench package with rear panel with perfo louvred panels



- Framework bench 2000 x 750 mm
- Height-adjustable legs
- Beech multiplex worktop
- Rear panel with: perfo louvred panel, 8x bottBox M1, 16x bottBox M2, 12x bottBox M3
- Optional design with drawer cabinet



Dimensions W x D [mm]	2000 x 750	2000 x 750
Work height table top from - to [mm]	740-1140	740-1140
total height from - to [mm]	1.220 - 1.620	1.220 - 1.620
Version	Without drawer cabinet	With drawer cabinet
Quantity of drawers		1845
Front height [mm]		2x150
Stringers bottom	Yes	Yes
Load capacity [kg]	600	600
Worktops	Beech Multiplex	Beech Multiplex
Order ref.	41003555.16V	41003560.16V

Framework benches

Workbench package with rear panel with perfo perforated panels



- Framework bench 2000 x 750 mm
- Height-adjustable legs
- Beech multiplex worktop
- Rear panel with 11 part perfo hook kit



Dimensions W x D [mm]	2000 x 750	2000 x 750
Work height table top from - to [mm]	740-1140	740-1140
total height from - to [mm]	1220 - 1620	1220 - 1620
Version	Without drawer cabinet	With drawer cabinet
Quantity of drawers		1845
Front height [mm]		2x150
Stringers bottom	Yes	Yes
Load capacity [kg]	600	600
Worktops	Beech Multiplex	Beech Multiplex
Order ref.	41003554.16V	41003559.16V

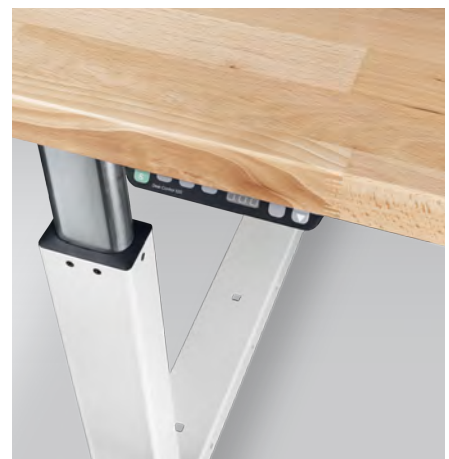

Framework and storage bench accessories from page 156

Framework benches

Framework benches with hydraulic height adjustment with electric motor



- Large height adjustment range of 380 mm to enable selection of the optimum working height
- Hydraulic height adjustment with electric motor via control panel
- To protect against damage, the control panel can be pushed in behind the front edge of the workbench
- Includes floor plates for fixing the workbench to the floor
- Stable base frame
- Load capacity: 400 kg
- Frame dimensions identical to standard framework bench, compatible with standard steel / wood base shelves
- 40 mm worktop, oiled

Dimensions W x D [mm]	1500 x 750	1500 x 750
Work height table top from - to [mm]	680-1060	680-1060
Stringers bottom	Yes	Yes
Worktops	Red beech	Beech Multiplex
Order ref.	41003308.16V	41003307.16V

Framework benches with hydraulic height adjustment with hand crank



- Large height adjustment range of 380 mm to enable selection of the optimum working height
- Load-independent, very light hydraulic height-adjustment with hand crank
- To protect against damage, the hand crank can be retracted behind the front edge of the workbench
- Includes floor plates for fixing the workbench to the floor
- Stable base frame
- Load capacity: 400 kg
- Frame dimensions identical to standard framework bench, compatible with standard steel / wood base shelves
- 40 mm worktop, oiled

Dimensions W x D [mm]	1500 x 750	1500 x 750
Work height table top from - to [mm]	680-1060	680-1060
Stringers bottom	Yes	Yes
Worktops	Red beech	Beech Multiplex
Order ref.	41003306.16V	41003305.16V

	.11			.24	.19
Housing:	Top, base and fronts: Details on page 15				
RAL 7035 – light grey	RAL 5010 – gentian blue	RAL 7035 – light grey	RAL 3004 – crimson red	RAL 7016 – anthracite grey	

Framework benches

Framework and storage workbenches



Framework benches

Framework benches with adjustable work height



- Heavy duty, braced steel section construction
- Adjustable height
- Durable, 40mm thick worktop
- Durable powder coat finish
- Add bott cubio cabinets as required



Dimensions W x D [mm]	1500 x 750	1500 x 750	1500 x 750	1500 x 750
Work height table top from - to [mm]	740-1140	740-1140	740-1140	740-1140
Stringers bottom	No	No	Yes	Yes
Load capacity [kg]	800	1000	800	1000
Worktop	Beech Multiplex	Red beech	Beech Multiplex	Red beech
Order ref.	41003109.16V	41003110.16V	41003118.16V	41003119.16V



Dimensions W x D [mm]	2000 x 750	2000 x 750	2000 x 750	2000 x 750
Work height table top from - to [mm]	740-1140	740-1140	740-1140	740-1140
Stringers bottom	No	No	Yes	Yes
Load capacity [kg]	600	1000	600	1000
Worktop	Beech Multiplex	Red beech	Beech Multiplex	Red beech
Order ref.	41003205.16V	41003206.16V	41003214.16V	41003215.16V

Framework benches

Framework benches with adjustable work height



■ 2 height-adjustable legs



Dimensions W x D [mm]	1500 x 750	1500 x 750	2000 x 750	2000 x 750
Work height table top from - to [mm]	740-1140	740-1140	740-1140	740-1140
Quantity of drawers	1846	1846	1846	1846
Front height [mm]	2x75, 1x150	2x75, 1x150	2x75, 1x150	2x75, 1x150
Stringers bottom	No	No	No	No
Load capacity [kg]	1000	300	1000	300
Worktop	Red beech	Beech Multiplex	Red beech	Beech Multiplex
Order ref.	41003471.19V	41003536.19V	41003473.19V	41003537.19V



Dimensions W x D [mm]	1500 x 750	1500 x 750	2000 x 750	2000 x 750
Work height table top from - to [mm]	740-1140	740-1140	740-1140	740-1140
Quantity of drawers	1847	1847	1847	1847
Front height [mm]	2x75, 1x150, 1x200	2x75, 1x150, 1x200	2x75, 1x150, 1x200	2x75, 1x150, 1x200
Stringers bottom	Yes	Yes	Yes	Yes
Load capacity [kg]	1000	800	1000	600
Worktop	Red beech	Beech Multiplex	Red beech	Beech Multiplex
Order ref.	41003167.19V	41003166.19V	41003263.19V	41003262.19V



Framework and storage bench accessories from page 156

Framework benches

Framework benches with fixed work height



- 1 leg
- 1 drawer cabinet, 5 drawers with standard duty slide



Dimensions W x D [mm]	1500 x 750	1500 x 750	2000 x 750	2000 x 750
Quantity of drawers	1848	1848	1848	1848
Front height [mm]	2x100, 2x150, 1x200	2x100, 2x150, 1x200	2x100, 2x150, 1x200	2x100, 2x150, 1x200
Load capacity [kg]	1500	1200	1200	700
Worktop	Red beech	Beech Multiplex	Red beech	Beech Multiplex
Order ref.	41003446.**V	41003315.**V	41003454.**V	41003323.**V



Dimensions W x D [mm]	2000 x 750	2000 x 750	2000 x 750	2000 x 750
Quantity of drawers	1852, 1 Tür	1852, 1 Tür	1856	1856
Front height [mm]	6x100, 2x150, 1x175	6x100, 2x150, 1x175	8x100, 4x150, 1x200	8x100, 4x150, 1x200
Load capacity [kg]	1200	1500	1200	1500
Worktop	Red beech	Beech Multiplex	Red beech	Beech Multiplex
Order ref.	41003242.**V	41003241.**V	41003518.**V	41003517.**V



Housing: RAL 7035 – light grey

Top, base and fronts: Details on page 15

RAL 5010 – gentian blue RAL 7035 – light grey RAL 3004 – crimson red RAL 7016 – anthracite grey

Framework benches

Mobile framework benches



- 2 height adjustable legs with 4 swivel and brake castors



Dimensions W x D [mm]	1500 x 750	1500 x 750	2000 x 750	2000 x 750
Work height table top from - to [mm]	840-1140	840-1140	840-1140	840-1140
Stringers bottom	Yes	Yes	Yes	Yes
Load capacity [kg]	300	300	300	300
Worktop	Red beech	Beech Multiplex	Red beech	Beech Multiplex
Order ref.	41003284.16V	41003283.16V	41003293.16V	41003292.16V



Dimensions W x D [mm]	1500 x 750	1500 x 750	2000 x 750	2000 x 750
Work height table top from - to [mm]	840-1140	840-1140	840-1140	840-1140
Quantity of drawers	1846	1846	1846	1846
Front height [mm]	2x75, 1x150	2x75, 1x150	2x75, 1x150	2x75, 1x150
Stringers bottom	Yes	Yes	Yes	Yes
Load capacity [kg]	300	300	300	300
Worktop	Red beech	Beech Multiplex	Red beech	Beech Multiplex
Order ref.	41003484.19V	41003539.19V	41003485.19V	41003540.19V



Framework and storage bench accessories from page 156

Framework benches



Accessories for framework and storage benches

Mounting frame kit with swivel frame, perfo perforated panel and bottBoxes



- For installation directly on a worktop
- Shelf trays equipped with bottBox M3 (130 x 298 x 165 mm)
- perfo perforated panel
- Swivel frame with shelf tray and perfo perforated panel for the ergonomic arrangement of assembly fixings
- Optional with LED strip light LB
- Colour: light grey (RAL 7035)
- Workbench not included in delivery
- For configurations with strip lights, a compatible GST-18 connection cable is also required

System width [mm]	900		1350	
Dimensions W x D x H [mm]	900 x 435 x 1357		1350 x 435 x 1357	
Version	1x perfo perforated panel, shelf with 10 bottBoxes, –	1x perfo perforated panel, shelf tray with 10 bottBoxes and LED strip light LB (30/40/50W)	1x perfo perforated panel, shelf with 14 bottBoxes, –	1x perfo perforated panel, shelf tray with 14 bottBoxes and LED strip light LB (30/40/50W)
Order ref.	41011139.16	41011141.16	41011140.16	41011142.16

Mounting frame kit with 2 swivel frames, strip light and bottBoxes



- For installation directly on a worktop
- Shelf trays equipped with bottBox M3 (130 x 298 x 165 mm)
- perfo perforated panel
- 2 swivel frames with shelf tray and perfo perforated panel for the ergonomic arrangement of assembly fixings
- Optional with LED strip light LB
- Colour: light grey (RAL 7035)
- Workbench not included in delivery
- For configurations with strip lights, a compatible GST-18 connection cable is also required

System width [mm]	900	
Dimensions W x D x H [mm]	900 x 645 x 1357	
Version	1x perfo perforated panel, shelf with 14 bottBoxes, –	1x perfo perforated panel, shelf tray with 14 bottBoxes and LED strip light LB (30/40/50W)
Order ref.	41011143.16	41011144.16

Accessories for framework and storage benches

Mounting frame kit with perfo perforated/louved panel and bottBoxes



- For mounting directly on a worktop
- Shelves kitted with bottBox M3 (130 x 298 x 165 mm)
- Optional perfo perforated or louved panels
- Colour: light grey (RAL 7035)
- Workbench not included

System width [mm]	900		1350		1800	
Dimensions W x D x H [mm]	900 x 435 x 1357		1350 x 435 x 1357		1800 x 435 x 1357	
Version	perfo perforated panel, shelf with 6 bottBoxes	perfo slotted panel, shelf with 6 bottBoxes	perfo perforated panel, shelf with 10 bottBoxes	perfo louvred panel, shelf with 10 bottBoxes	perfo perforated panel, shelf with 13 bottBoxes	perfo louvred panel, shelf with 13 bottBoxes
Order ref.	41011073.16	41011146.16	41011074.16	41011147.16	41011075.16	41011148.16

Mounting frame kit with strip light, perfo perforated/louved panel and bottBoxes



- For installation directly on a worktop
- Shelf trays equipped with bottBox M3 (130 x 298 x 165 mm)
- Optional perfo perforated or louved panels
- LED strip light LB
- Colour: light grey (RAL 7035)
- Workbench not included in delivery
- For configurations with strip lights, a compatible GST-18 connection cable is also required

System width [mm]	1350		1800	
Dimensions W x D x H [mm]	1350 x 645 x 1357		1800 x 645 x 1357	
Version	perfo perforated panel, shelf tray with 10 bottBoxes, LED strip light LB (30/40/50W)	perfo louvred panel, shelf tray with 10 bottBoxes, LED strip light LB (30/40/50W)	perfo perforated panel, shelf tray with 13 bottBoxes, LED strip light LB (30/40/50W)	perfo louvred panel, shelf tray with 13 bottBoxes, LED strip light LB (30/40/50W)
Order ref.	41011137.16	41011149.16	41011138.16	41011150.16

	.11	.16	.24	.19	 .20
Housing: RAL 7035 – light grey	Top, base and fronts: Details on page 15 RAL 5010 – gentian blue RAL 7035 – light grey RAL 3004 – crimson red RAL 7016 – anthracite grey				ESD version available RAL 7035 – light grey

Accessories for framework and storage benches

Mounting frames



- For mounting directly on a worktop
- The purpose is to provide an ergonomic working environment
- Kitted with extensive accessories such as shelves, perforated and louvred panels and other extension elements
- Colour: light grey (RAL 7035)

For system width [mm]	900	1350	1800
Dimensions W x D x H [mm]	900 x 140 x 1357	1350 x 140 x 1357	1800 x 140 x 1357
Order ref.	41011070.16	41011071.16	41011072.16

Shelf trays for mounting frames



- Made of powder-coated sheet steel
- With hooks for hooking into the cubio mounting frame
- Raised lip on one side, 20 mm high
- Shelf tray can optionally be installed with the raised lip on the front or the back
- Inclination continually adjustable by +/- 30°
- Depth-adjustable
- Load capacity 60 kg
- Colour: light grey (RAL 7035)

system width [mm]	450	450	675	675	900
Dimensions W x D x H [mm]	450 x 200 x 55	450 x 350 x 55	675 x 200 x 55	675 x 350 x 55	900 x 200 x 55
Order ref.	42105001.16	42105005.16	42105044.16	42105045.16	42105002.16

system width [mm]	900	1350	1350	1800	1800
Dimensions W x D x H [mm]	900 x 350 x 55	1350 x 200 x 55	1350 x 350 x 55	1800 x 200 x 55	1800 x 350 x 55
Order ref.	42105006.16	42105003.16	42105007.16	42105004.16	42105008.16

Accessories for framework and storage benches

perfo louvred panels

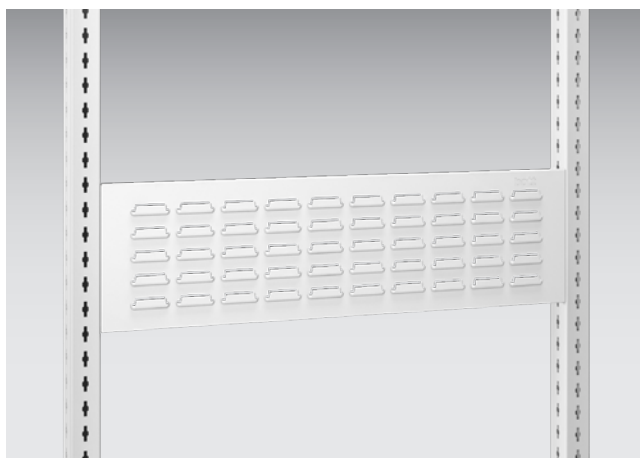

- Available in 2 heights
- With perfo louvred form
- For attaching perfo adapters for holders and accessories from the bott perfo product range as well as shelf boxes and stock boxes
- For installation on the avero vertical profile
- Load capacity 40 kg
- Made of conductive powder-coated sheet steel
- Colour: light grey (RAL 7035)

system width [mm]	675	900	1350	1800
Suitable for swivel frames	Yes	No	No	No
Dimensions W x D x H [mm]	675 x 43 x 240	900 x 36 x 240	1350 x 36 x 240	1800 x 36 x 240
Order ref.	14025388.20	14025361.20	14025362.20	14025363.20

system width [mm]	675	900	1350	1800
Suitable for swivel frames	Yes	No	No	No
Dimensions W x D x H [mm]	675 x 43 x 480	900 x 36 x 480	1350 x 36 x 480	1800 x 36 x 480
Order ref.	14025389.20	14025365.20	14025366.20	14025367.20

Accessories for framework and storage benches

perfo perforated panels

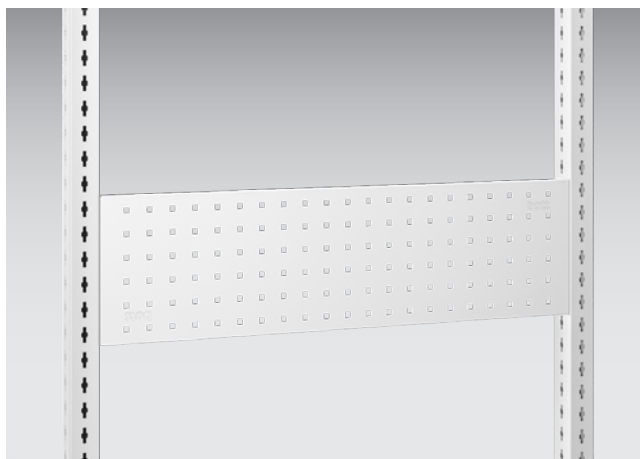

- Available in 3 heights
- 9.2 x 9.2 mm square perforation in 38.1 mm pitch
- For attaching holders and accessories from the bott perfo product range
- For installation on the avero vertical profile
- Load capacity 40 kg
- Made of conductive powder-coated sheet steel
- Colour: light grey (RAL 7035)

system width [mm]	675	900	1350	1800
Suitable for swivel frames	Yes	No	No	No
Dimensions W x D x H [mm]	675 x 36 x 240	900 x 36 x 240	1350 x 36 x 240	1800 x 36 x 240
Order ref.	14025386.20	14025341.20	14025342.20	14025343.20

system width [mm]	675	900	1350	1800
Suitable for swivel frames	Yes	No	No	No
Dimensions W x D x H [mm]	675 x 36 x 480	900 x 36 x 480	1350 x 36 x 480	1800 x 36 x 480
Order ref.	14025387.20	14025345.20	14025346.20	14025347.20

Rear panel set with perfo louvred panel and bottBoxes



- For mounting directly on a worktop
- Kitted with bottBoxes M1 (130 x 100 x 65 mm) M2 (130 x 198 x 90 mm) M3 (130 x 298 x 165 mm)
- High stability thanks to vertical struts
- Colour: light grey (RAL 7035)
- Workbench not included

Dimensions W x D x H [mm]	1500 x 230 x 480	1500 x 230 x 960	2000 x 230 x 480	2000 x 230 x 960
Version	12x bottBox M1, 24x bottBox M2	24x bottBox M1, 36x bottBox M2	8x bottBox M1, 16x bottBox M2, 12x bottBox M3	16x bottBox M1, 24x bottBox M2, 24x bottBox M3
Number of perfo panels	1	1	1	1
Order ref.	41011125.16	41011128.16	41011127.16	41011130.16

Accessories for framework and storage benches

Rear panel with perfo louvred panels



- For mounting directly on a worktop
- For mounting bottBoxes
- High stability thanks to vertical struts
- Colour: light grey (RAL 7035)
- Workbench not included

Dimensions W x D x H [mm]	1500 x 230 x 480	1500 x 230 x 960	2000 x 230 x 480	2000 x 230 x 960
Number of perfo panels	1	1	1	2
Order ref.	41011117.16	41011120.16	41011119.16	41011122.16

Rear panel set with perfo combi-panels and bottBoxes



- For mounting directly on a worktop
- Kitted with bottBoxes M1 (130 x 100 x 65 mm) M2 (130 x 198 x 90 mm) M3 (130 x 298 x 165 mm)
- High stability thanks to vertical struts
- Colour: light grey (RAL 7035)
- Workbench not included

Dimensions W x D x H [mm]	1500 x 245 x 480	1500 x 230 x 960	2000 x 350 x 480	2000 x 230 x 960
Version	8x bottBox M1, 12x bottBox M2	16x bottBox M1, 24x bottBox M2	8x bottBox M1, 12x bottBox M2, 4x bottBox M3	16x bottBox M1, 24x bottBox M2, 8x bottBox M3
Number of perfo panels	1	1	1	1
Order ref.	41011135.16	41011129.16	41011136.16	41011131.16

	.11	.16	.24	.19		.20
Housing: RAL 7035 – light grey	Top, base and fronts: Details on page 15 RAL 5010 – gentian blue RAL 7035 – light grey RAL 3004 – crimson red RAL 7016 – anthracite grey				ESD version available RAL 7035 – light grey	

Accessories for framework and storage benches

Rear panel with perfo combi-panels

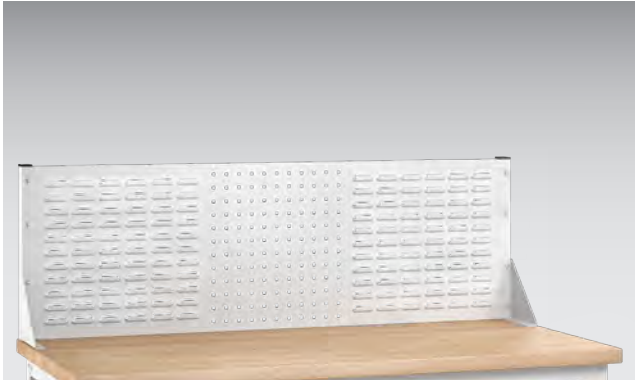

- For mounting directly on a worktop
- For attaching perfo accessories
- For mounting bottBoxes
- High stability thanks to vertical struts
- Colour: light grey (RAL 7035)
- Workbench not included

Dimensions W x D x H [mm]	1500 x 230 x 480	1500 x 230 x 960	2000 x 230 x 480	2000 x 230 x 960
Number of perfo panels	1	1	1	1
Order ref.	41011157.16	41011121.16	41011158.16	41011123.16

Rear panel with perfo perforated panels and hook kit

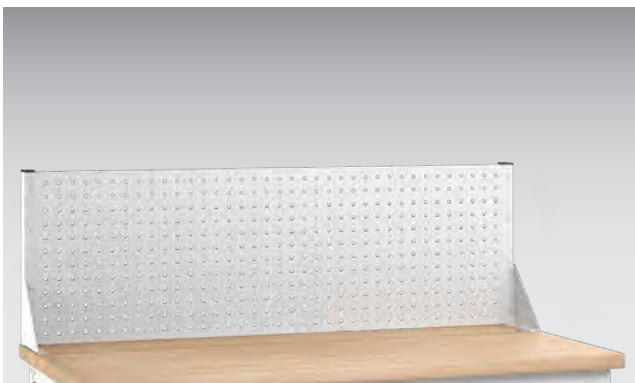

- For mounting directly on a worktop
- For attaching perfo accessories
- High stability thanks to vertical struts
- Colour: light grey (RAL 7035)
- Workbench not included



Dimensions W x D x H [mm]	1500 x 230 x 480	1500 x 230 x 960	2000 x 230 x 480	2000 x 230 x 960
Version	With 11-piece perfo hook set	With 25-piece perfo hook set	With 11-piece perfo hook set	With 25-piece perfo hook set
Number of perfo panels	1	1	1	1
Order ref.	41011124.16	41011078.16	41011126.16	41011079.16

Accessories for framework and storage benches

Rear panel with perfo perforated panels

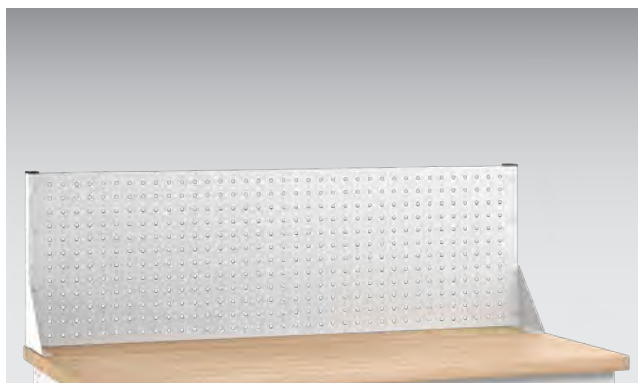

- For mounting directly on a worktop
- For attaching perfo accessories
- High stability thanks to vertical struts
- Colour: light grey (RAL 7035)
- Workbench not included

Dimensions W x D x H [mm]	1500 x 230 x 480	1500 x 230 x 960	2000 x 230 x 480	2000 x 230 x 960
Number of perfo panels	1	1	1	1
Order ref.	41011116.16	41011076.16	41011118.16	41011077.16

Brush matting for work surfaces



- Can be attached to work surfaces (e.g. worktops) with screws
- Used where sensitive parts are assembled (scratch protection)
- Bristle height: 15 mm
- Bristle material: Polyamide 6 black (Fibre diameter 0.4 mm) Fibre material support: Polypropylene, grey (RAL 7011)
- Supplied in packs of 20 individual segments corresponds to 1 m²

Dimensions W x D x H [mm]	500 x 100 x 27
Pack of	20
Order ref.	41010053.10V

	.11	.16	.24	.19		.20
Housing: RAL 7035 – light grey	Top, base and fronts: Details on page 15 RAL 5010 – gentian blue RAL 7035 – light grey RAL 3004 – crimson red RAL 7016 – anthracite grey				ESD version available RAL 7035 – light grey	

Accessories for framework and storage benches

Worktop protection mat



- Two-layer, low-maintenance PVC coating
- High resistance to friction and wear
- Permanently elastic
- Anti-static
- Semi-gloss surface
- Colour: grey, mottled
- Material thickness 2 mm

Dimensions W x D x H [mm]	1450 x 700 x 2	1950 x 700 x 2
Pack of	1	1
Order ref.	41010136.90V	41010137.90V

Worktop upstand made of beech multiplex



- Made of beech veneers cross laminated to form multiple layers
- Prepared for attachment to worktops at the front
- The upstands can be screwed on the left or right

Worktop upstand	Back (1 piece)	Back (1 piece)	Side (1 pair)	Side (1 piece)
Dimensions W x D x H [mm]	1500 x 15 x 85	2000 x 15 x 85	15 x 750 x 85	15 x 750 x 85
Order ref.	41203002.08V	41203003.08V	41203004.08V	41203010.08V

Accessories for framework and storage benches

Height-adjustable shelf tray



- For installation on the worktop
- Infinitely variable height adjustable with large star grip screw
- 3-sided safety lip (height 40 mm)
- With anti-slip mat
- Colour: light grey (RAL 7035)

For workbench with width [mm]	1500	2000
Dimensions W x D x H [mm]	1500 x 300 x 345	2000 x 300 x 345
Order ref.	12115003.16	12115004.16

perfo side panel



- Fits to the end of a framework or storage bench
- With perfo perforation for attaching all holders and hooks from the perfo range

For workbench leg	Framework bench, static	Framework bench, mobile	Storage bench
Dimensions W x D x H [mm]	1 x 610 x 692	1 x 610 x 642	25 x 570 x 560
Order ref.	41010016.**V	41010094.**V	41010001.**V

	.11	.16	.24	.19	 .20
Housing: RAL 7035 – light grey	Top, base and fronts: Details on page 15 RAL 5010 – gentian blue RAL 7035 – light grey RAL 3004 – crimson red RAL 7016 – anthracite grey				ESD version available RAL 7035 – light grey

Accessories for framework and storage benches

Vices



- Forged steel vices
- Hardened jaw and anvil
- Standard model includes 2 additional pipe clamping jaws for securely clamping pipes
- Adjustable guides, scraper keeps guide rails dirt-free
- Vices can be combined with a turntable, height adjuster (except jaw width 175 mm) and collapsible lift (only jaw width 120 mm)
- Colour: anthracite grey



Jaw width [mm]	100	120	135	150	175
Jaw depth [mm]	60	75	85	100	105
Dimensions W x D x H [mm]	120 x 300 x 117	150 x 300 x 144	160 x 430 x 170	180 x 480 x 188	210 x 520 x 208
Order ref.	80601019.19V	80601020.19V	80601021.19V	80601022.19V	80601023.19V

Collapsible lift and height adjuster for vice



- With gas strut supported height adjustment
- Easy adjustment using tilt-clamp lever
- Height adjustment range 155 mm
- 360° rotation possible
- Vice can be swung down under the worktop
- Colour: anthracite grey



For vice with jaw width [mm]	125
Order ref.	80613011.19V

Accessories for framework and storage benches

Bench vice lift



- With gas strut supported height adjustment
- Easy adjustment using tilt-clamp lever
- Height adjustment range: 240 mm
- 360° rotation possible
- Colour: anthracite grey





For vice with jaw width [mm]	100	120	135	150
Order ref.	80613008.19V	80613009.19V	80613009.19V	80613010.19V

Turntable for vice



- Forged steel turntable for vice
- Tilt-clamp lever for easy adjustment (360° rotation possible)
- With fixing kit
- Colour: anthracite grey

For vice with jaw width [mm]	100	120	135	150	175
Order ref.	80610005.19V	80610006.19V	80610007.19V	80610008.19V	80610009.19V

	 .11	 .16	 .24	 .19	 .20
Housing:	Top, base and fronts: Details on page 15				ESD version available
RAL 7035 – light grey	RAL 5010 – gentian blue	RAL 7035 – light grey	RAL 3004 – crimson red	RAL 7016 – anthracite grey	RAL 7035 – light grey

Accessories for framework and storage benches

Protective vice jaws for vice



- Robust plastic for holding sensitive surfaces carefully
- With magnetic strips inserted on the inside for secure hold on the vice jaw
- One outer side with horizontal and vertical V shaped grooves for holding round parts in place, other outer side smooth
- Delivery: in pairs
- Colour: yellow

For vice with jaw width [mm]	100	125	150
Order ref.	80602001.90V	80602002.90V	80602003.90V

Accessories for framework benches

Shelves made of steel and beech multiplex

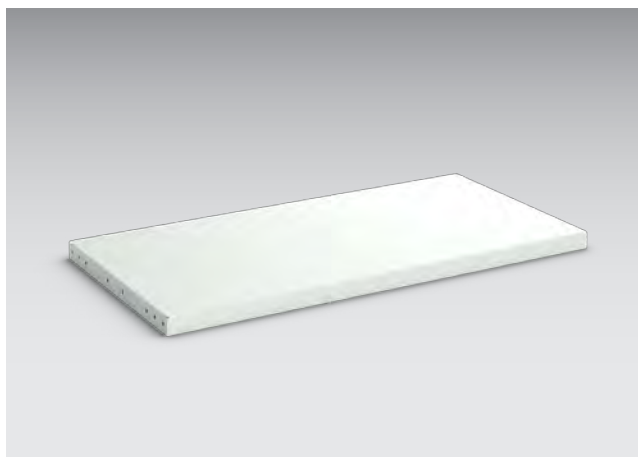

- Storage shelves made of sheet steel and beech multiplex for bolting between workbench legs
- Thickness with sheet steel: 50 mm Thickness with oiled beech multiplex: 25 mm
- Designs with either full or half depth
- Colour: light grey (RAL 7035)/natural beech



For workbench width [mm]	1500	1500	1500
Dimensions W x D [mm]	1500 x 400	1500 x 750	1500 x 750
Material	Sheet steel	Sheet steel	Beech ply
Order ref.	41201049.16V	41201050.16V	41201044.08V



For workbench width [mm]	2000	2000	2000
Dimensions W x D [mm]	2000 x 650	2000 x 750	2000 x 750
Material	Sheet steel	Sheet steel	Beech ply
Order ref.	41201055.16V	41201056.16V	41201046.08V

Accessories for framework benches

Side shelf tray



- Suitable for side mounting on all cubio framework bench legs, e.g. as computer shelf
- Shelf surface W 290 x D 650 mm
- For a system depth of 750 mm
- Load capacity: 15 kg
- Colour: light grey (RAL 7035)

Version	Side shelf
Dimensions W x D x H [mm]	293 x 650 x 20
Order ref.	41010135.20V

Socket strip with carrier rail



- For side mounting on all cubio framework bench legs
- 3 Schuko sockets
- On/off switch
- Connection cable 5 m with Schuko plug
- For a system depth of 750 mm
- Colour: light grey (RAL 7035)

Version	Socket strip with carrier rail
Dimensions W x D x H [mm]	47 x 644 x 143
Order ref.	41010134.20V

Accessories for framework benches

perfo side panel



- For side mounting on all cubio system workbench bench legs
- For attaching all accessories from the perfo range
- Suitable for static and mobile workbenches
- For a system depth of 750 mm
- Colour: light grey (RAL 7035)

Version	perfo side panel
Dimensions W x D x H [mm]	21 x 644 x 143
Order ref.	41010133.20V

varioSlide individual drawer



- Plastic varioSlide drawer, pull-out/removable
- Metallic housing with plastic guide rails for bolting directly under the worktop for work benches without stringer sets
- When mounting on a work bench with stringer set one carrier rail is required
- Load capacity 20 kg
- Colour: anthracite grey (RAL 7016)

Version	Metal housing with varioSlide drawer	Metal housing with varioSlide drawer	for 750mm deep benches
Dimensions W x D x H [mm]	458 x 435 x 207	570 x 435 x 207	45 x 640 x 29
Order ref.	40032041.19	40032042.19	41010026.16V

	.11	.16	.24	.19		.20
Housing: RAL 7035 – light grey	Top, base and fronts: Details on page 15 RAL 5010 – gentian blue RAL 7035 – light grey RAL 3004 – crimson red RAL 7016 – anthracite grey				ESD version available RAL 7035 – light grey	

Accessories for framework benches

Retractable bottBox M4



- To be mounted below the worktop
- The bottBox can be used as a simple drawer
- bottBoxes protected from accidental removal
- The set consists of the adaptor plate and 1x bottBox M4
- Colour: anthracite grey (RAL 7016)



Version	Retractable bottBoxes M4
Dimensions W x D x H [mm]	130 x 398 x 165
Order ref.	40032024.19

Back panel



- For mounting on back
- Height: 662 mm
- Also suitable for workbenches in rows
- Colour: light grey (RAL 7035)

For workbenches with width [mm]	1500	2000
Order ref.	41010107.16V	41010108.16V

Accessories for framework benches

Workbench legs with incremental height adjustment



- Height-adjustable in increments of 25 mm
- Adjustment range 700 – 1100 mm
- With a fixing kit
- Colour: light grey (RAL 7035)

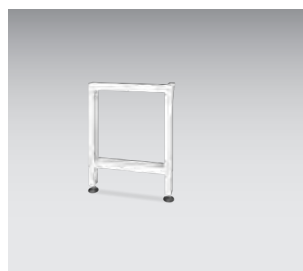

Version	Standard	Standard	With height adjustable foot (levelling range: ±10 mm)
Adjustment range leg [mm]	700-1100	700-1100	700-1000
Dimensions W x D [mm]	80 x 650	80 x 800	80 x 650
Order ref.	41401005.16V	41401006.16V	41401029.16V

Accessories for framework benches

Stringer sets

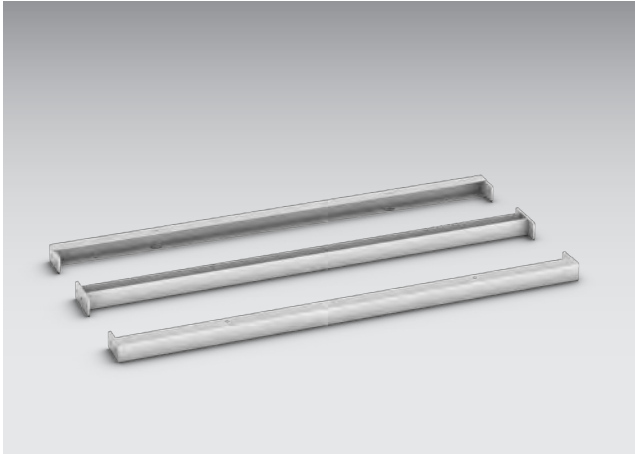

- Stringer set for constructing a frame by bolting between 2 workbench legs
- Improves worktop rigidity
- Increases load capacity
- 2 stringers above and 1 stringer below
- Colour: light grey (RAL 7035)

For width [mm]	1500	2000
Order ref.	41010020.16V	41010022.16V

Round support leg



- To be mounted below a worktop
- Including height adjustable foot
- Diameter: 80 mm
- Colour: light grey (RAL 7035)

Height [mm]	800	900
Order ref.	11401108.16V	11401109.16V

Beech multiplex



- Material: Solid beech
- Top side: oiled
- Underside: oiled
- Colour: Beech natural
- Data: Surface resistant to water, oils, acids and chemicals, highly abrasion-resistant and acid-resistant
- Joints spliced, thus high load capacity
- Fire protection class D-s2, d0 (previously: B2)

Width [mm]	1500	2000
Depth [mm]	750	750
Worktop thickness [mm]	40	40
Order ref.	41201033.08V	41201036.08V

Red beech



- Material: Solid beech
- Top side: oiled
- Underside: oiled
- Colour: Beech natural
- Data: Surface resistant to water, oils, acids and chemicals, highly abrasion-resistant and acid-resistant
- Joints spliced, thus high load capacity
- Fire protection class D-s2, d0 (previously: B2)

Width [mm]	1500	2000
Depth [mm]	750	750
Worktop thickness [mm]	40	40
Order ref.	41201033.07V	41201036.07V

	.11	.16	.24	.19		.20
Housing: RAL 7035 – light grey	Top, base and fronts: Details on page 15 RAL 5010 – gentian blue RAL 7035 – light grey RAL 3004 – crimson red RAL 7016 – anthracite grey				ESD version available RAL 7035 – light grey	

CNC - Storage systems

CNC cupboards and accessories



CNC - Storage systems



CNC system cabinets

- Safe, clean and clear storage of expensive tools
- For attaching internal drawers and slide-out carriers
- Internal drawers and slide-out carriers can be configured with tool carriers or tool inserts



CNC inserts and carriers

- CNC inserts can be fitted and removed without tools
- Carriers for use in CNC trolleys, CNC workbench stands, CNC cabinets



CNC drawer cabinets

- Safe, clean and clear storage of expensive tools
- For use with tool carriers and CNC insert trays



CNC trolleys

- Clear, mobile arrangement of tools
- 6 or 12 tool carriers can be attached

CNC storage systems

Drawer cabinet height 1000 mm - width 800 mm



■ Drawer cabinet incl. 3 CNC drawer frames height 125 mm

Depth [mm]	650
version	Heavy duty
Quantity of drawers	3
Front height [mm]	3x300
Order ref.	40020151.**V

CNC cupboards and accessories



CNC storage systems

CNC drawer frame



- For mounting in drawers and internal drawers
- For individual kitting with tool inserts
- The height of the drawer front depends on the highest stored tool
- The selection of 80 or 125 mm as the height of the drawer insert depends on the stored tool size and the length of the respective mounting shanks
- Colour: light grey (RAL 7035)



Width [mm]	525	525	650	650	800	800
Depth [mm]	650	650	650	650	650	650
Module widths per row	15	15	20	20	26	26
Order ref.	43013011.16V	43013012.16V	43013013.16V	43013014.16V	43013015.16V	43013016.16V

Width [mm]	1050	1050	1300	1300
Depth [mm]	650	650	650	650
Module widths per row	36	36	46	46
Order ref.	43013017.16V	43013018.16V	43013019.16V	43013020.16V

	.11	.16	.24	.19		.20
Housing: RAL 7035 – light grey	Top, base and fronts: Details on page 15 RAL 5010 – gentian blue RAL 7035 – light grey RAL 3004 – crimson red RAL 7016 – anthracite grey				ESD version available RAL 7035 – light grey	

CNC storage systems

Cupboard with hinged doors - kitted



- With CNC sliding shelf for attaching tool inserts
- With CNC tool carrier sliding shelf with 4 removable CNC tool carriers for the attachment of tool inserts
- With 2 drawers incl. 2 CNC drawer frames, height 125 mm

Width [mm]	800
Depth [mm]	650
Height [mm]	2000
Order ref.	40020150.19V

CNC cupboards and accessories



CNC storage systems

Cupboard with hinged doors - empty



- for custom fitting: - CNC sliding shelf - CNC tool carriers - internal drawers

Width [mm]	800	800	800
Depth [mm]	650	650	650
Height [mm]	800	1000	2000
Order ref.	40020163.19V	40020085.19V	40020091.19V

CNC sliding shelf frame



- For individual kitting with tool inserts in four rows
- Insert pulled out forwards by means of a heavy duty slide
- Optimal accessibility of tools thanks to the slide and the inclined top surface
- Ergonomic removal thanks to inclined attachment
- Superior overview
- Easy ergonomic kitting when slide pulled out
- Optimised use of available storage space, no additional space required in cabinet to remove tools from above
- Suitable for cubio system cabinets with width 800 x depth 650 mm
- Load capacity: 200 kg
- Colour: light grey (RAL 7035)

Height [mm]	220
Module widths per row	24
Order ref.	40523004.16V

CNC storage systems

CNC tool carrier sliding shelf



- For attaching 4 tool carriers width 590 mm
- Insert pulled out forwards by means of a heavy duty slide
- Optimal accessibility of tools thanks to the slide and the inclined top surface
- Ergonomic removal thanks to inclined attachment
- Superior overview
- Easy ergonomic kitting when slide pulled out
- Optimised use of available storage space, no additional space required in cabinet to remove tools from above
- Suitable for installation in cubio system cabinets with width 800 x depth 650 mm
- Load bearing capacity: 200 kg
- Colour: light grey (RAL 7035)

Height [mm]	220
Module widths per row	20
Order ref.	40523003.16V

Internal drawers



- Drawer for customising an empty housing
- For system width 650 mm
- Standard duty slides 75 kg load capacity, full extension
- Heavy duty slides 200 kg load capacity, full extension
- Colour: light grey (RAL 7035)

Width [mm]	800	800	800	800
Depth [mm]	650	650	650	650
Order ref.	40522037.16M	40522039.16M	40522038.16M	40522040.16M

CNC storage systems

CNC table stands for tool inserts



- For attaching CNC tool inserts
- Top tray is lined with ribbed rubber mat
- Tool inserts are ordered separately.
- Colour: light grey (RAL 7035)

Dimensions W x D x H [mm]	599 x 448 x 375
Module widths per row	20
Order ref.	15001011.16

CNC table stands for tool carriers



- For attaching CNC tool carriers
- Top tray is lined with ribbed rubber mat
- CNC tool carriers and tool inserts are ordered separately.
- Colour: light grey (RAL 7035)



Dimensions W x D x H [mm]	600 x 450 x 375
For tool carriers	3x width 590 mm
Order ref.	15001003.16

CNC storage systems

CNC heavy duty trolley



- Tools carriers are inserted in the heavy duty trolley using the universal holder (tool carrier tilt can be set in 3 positions: 0°, 15° and 30°)
- 2 swivel & brake castors and 2 fixed castors
- For up to 12 tool carriers width 590 mm
- Expandable - add on shelves with ribbed rubber mats
- Dimensions: W 670 x D 600 x H 980 mm
- Tool inserts are ordered separately.
- Colour: light grey (RAL 7035)



Dimensions W x D x H [mm]	670 x 600 x 985	670 x 600 x 900	270 x 600 x 35	200 x 28 x 100
version	Empty	Fitted with 12 tool carriers	Shelf	Pair of universal holders for tool carrier
Order ref.	10401029.16	10401052.16V	12102084.16	15003011.16

CNC transport trolley



- 2 swivel & brake castors and 2 fixed castors
- For up to 6 tool carriers width 590 mm
- Top tray is lined with ribbed rubber mat for placing 2 tool carriers width 590 mm
- Bracket tilt for tool carrier width 590 mm can be set in 3 positions: (0°, 15° and 30°)
- Dimensions: W 610 x D 650 x H 1020 mm
- Tool inserts are ordered separately.
- Colour: light grey (RAL 7035)



Dimensions W x D x H [mm]	650 x 710 x 1020	610 x 650 x 1020
version	Unloaded	Fitted with 6 tool carriers
Order ref.	10401030.16	10401053.16V

Tool inserts



- The tool insert can be fitted into and removed from the holder quickly and easily without tools or other means
- Material: ABS, black
- Used in:
 - CNC sliding shelf
 - CNC table stands
 - CNC tool carriers
 - CNC drawer frames

For CNC tools	ISO 30 / SK 30 / MORSE 3	ISO 35 / SK35 / MORSE 4	ISO 40 / SK40 / BT40
Width of tool insert [mm]	50 (2 MW)	75 (3 MW)	75 (3 MW)
Tool attachment Ø D1 [mm]	28	35	41
Order ref.	15002041	15002046	15002047

For CNC tools	ISO 45 / SK45 / MORSE 5	ISO 50 / SK50	HSK – A 40 / C 40 / E 40 / F 40 / B 50
Width of tool insert [mm]	75 (3 MW)	100 (4 MW)	50 (2 MW)
Tool attachment Ø D1 [mm]	49	67	30
Order ref.	15002048	15002053	15002042

For CNC tools	HSK – A 32 / C 32 / E 32 / F 32 / B 40	HSK – A 50 / C 50 / E 50 / F 50 / B 63 / F 63	HSK – A 63 / C 63 / E 63 / B 80
Width of tool insert [mm]	50 (2 MW)	75 (3 MW)	75 (3 MW)
Tool attachment Ø D1 [mm]	24	38	48
Order ref.	15002043	15002049	15002050

For CNC tools	HSK – A 80 / C 80 / E 80 / F 80 / B 100	HSK – A 100 / C 100 / E 100 / F 100 / B 125	Capto C3
Width of tool insert [mm]	100 (4 MW)	100 (4 MW)	50 (2 MW)
Tool attachment Ø D1 [mm]	60	75	23
Order ref.	15002054	15002055	15002093

CNC storage systems

Tool inserts

For CNC tools	Capto C4	Capto C6	Capto C5
Width of tool insert [mm]	50 (2 MW)	75 (3 MW)	75 (3 MW)
Tool attachment Ø D1 [mm]	29	46	37
Order ref.	15002094	15002096	15002095

For CNC tools	VDI 30	VDI 40	VDI 50
Width of tool insert [mm]	75 (3 MW)	75 (3 MW)	100 (4 MW)
Tool attachment Ø D1 [mm]	30	40	50
Order ref.	15002044	15002045	15002051

For CNC tools	VDI 60	Lege houder (voor aanpassing door de klant zelf)
Width of tool insert [mm]	100 (4 MW)	100 (4 MW)
Tool attachment Ø D1 [mm]	60	
Order ref.	15002052	15002056

CNC tool carriers

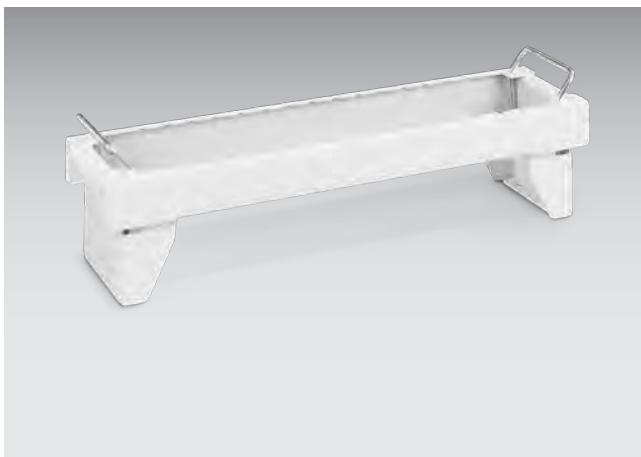

- For individual kitting with tool inserts
- For insertion in: CNC heavy duty trolley CNC transport rack CNC tool carrier CNC table stands
- Colour: light grey (RAL 7035)



Dimensions W x D x H [mm]	590 x 125 x 110
Order ref.	15001007.16V

CNC storage systems



avero – The Workstation system

Process optimisation

Ergonomics

Modularity & flexibility



The smart solution

The avero workstation storage system for manual assembly is ideal for suppliers producing small parts for the automotive industry, mechanical engineering SME's and manufacturers of electronics. avero provides flexible solutions for innovative production processes that integrate with robotics and intra-logistics interfaces. Digital assistance systems help to boost efficiency and reduce errors.

Whether you're looking for a single workstation; such as a packing bench, a lean point information board or a full workstation storage system as an assembly line, the avero modules can be adapted to your requirements.

The avero workstations are suitable both for modular single workstation assembly as well as for manufacturing lines, connected via roller conveyors including matching docking trolleys. The assembly tables are height-adjustable with a choice of electric or mechanical with a crank. Manual workstations can be set up in your production line as perfectly ergonomic working areas using avero.

Range of services



Fully modular system

- Individual configuration and flexible workstation layout
- Material provisioning and workpiece transport solutions
- Integration of IT components
- Hidden horizontal and vertical cable routing
- Optimum tool and material provisioning
- Numerous retrofitting options
- Option of incorporating numerous perfom accessories
- Common locking system can also be used in conjunction with cubio workshop equipment
- Optional combination with aluminium profile systems

ESD Protection

- Basic, conductive surfaces and component connections at ESD workstations
- Manufactured and tested according to IEC 61340-5-1
- Comprehensive solution, including advice, planning, implementation, certification, training, testing and auditing.
- ESD complete solutions are possible for overall production thanks to the integration of cubio drawers and cupboards.

Colour scheme



avero



3

Year warranty*

* bott grants the ultimate purchaser (end user), in addition to the statutory warranty claims, a 3-year product warranty according to bott warranty conditions. bott guarantees, for a period of 3 years from date of delivery, that the supplied products will be free from defects in terms of materials and workmanship. Warranty does not cover electronic components and modules.

Colour combination:

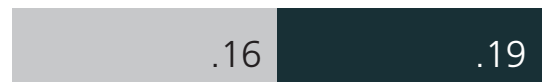

Colour combination: ESD



ESD light grey
RAL colour: 7035

ESD anthracite grey
RAL colour: 7016

The colour panels shown may not match the original colours for printing-related reasons.

Single workstations

Complete workstation 1



- 3x vertical profile
- 3x cable duct with brush strips for vertical profile
- 2x overhead arm for vertical profile
- Suspended drawer cabinet W 375 x D 500 x H 200 mm with 2x 100 mm drawers and lock
- Overhead rail with carriage
- LED ECO 28 W strip light with 5 m connecting cable and Schuko plug
- Retaining rail with 3 gang Shuko socket strip, ON/OFF switch and 3 m connection cable with Schuko plug
- 2x perfo panel 480 mm high for system width 450 mm
- perfo panel 240 mm high for system width 450 mm
- Shelf tray 350 mm deep for system width 450 mm, equipped with 3 bottBoxes size M3
- 2x shelf tray 200 mm deep for system width 450 mm, equipped with 3 bottBoxes size M2
- Swivel frame, system width 750 mm
- perfo panel for swivel frame
- Shelf tray 350 mm deep for swivel frame, equipped with 4 bottBoxes size M3
- Support rail for swivel frame, equipped with 5 bottBoxes size M1
- Laminate-coated worktop
- Table load 200 kg
- Total load with attachments 300 kg
- Supplied assembled for versions with hand crank and electric motor

Version	Height adjustment in increments	Height adjuster with hand crank	Height adjuster with electric motor
Dimensions W x D [mm]	1350 x 870	1350 x 870	1350 x 870
total height from - to [mm]	2.035-2.435	2.035-2.435	2.035-2.435
Work height table top from - to [mm]	743-1143	743-1143	743-1143
Dimensions Worktop W x D x H [mm]	1.500 x 750 x 30	1.500 x 750 x 30	1.500 x 750 x 30
Order ref.	41032014.16	41032008.16	41032004.16



Single workstations

Complete workstation 2



- 2x vertical profile
- 2x cable duct with brush strips for vertical profile
- 2x overhead arm for vertical profile
- Suspended drawer cabinet W 375 x D 500 x H 500 mm with 2x 200 mm drawers and lock
- Overhead rail with carriage
- LED ECO 42 W strip light with 5 m connecting cable and Schuko plug
- Retaining rail with 3 gang Shuko socket strip, ON/OFF switch and 3 m connection cable with Schuko plug
- perforated panel for system width 1350 mm, system height 240 mm
- Tray, 200 mm deep, kitted with 10 bottBoxes M2
- Tray, 350 mm deep, kitted with 10 bottBoxes M3
- Swivel arm with system frame
- perforated panel for system frames
- Tray, 200 mm deep, for system frame 450 mm, kitted with 4 bottBoxes M2
- Laminate-coated worktop
- Table load 200 kg

Version	Height adjustment in increments	Height adjuster with hand crank	Height adjuster with electric motor
Dimensions W x D [mm]	1350 x 870	1350 x 870	1350 x 870
total height from - to [mm]	2.035-2.435	2.035-2.435	2.035-2.435
Work height table top from - to [mm]	743-1143	743-1143	743-1143
Dimensions Worktop W x D x H [mm]	1.500 x 750 x 30	1.500 x 750 x 30	1.500 x 750 x 30
Order ref.	41032011.16	41032005.16	41032001.16

Single workstations

Complete workstation 3



- 2x vertical profile
- 2x cable duct with brush strips for vertical profile
- 2x overhead arm for vertical profile
- Suspended drawer cabinet W 225 x D 500 x H 500 mm with a 400 mm drawer and lock
- Overhead rail with carriage
- LED ECO 28 W strip light with 5 m connecting cable and Schuko plug
- Retaining rail with 3 gang Shuko socket strip, ON/OFF switch and 3 m connection cable with Schuko plug
- perfo perforated panel for system width 900 mm, system height 240 mm
- Tray, 200 mm deep, kitted with 6 bottBoxes M2
- Tray, 350 mm deep, kitted with 6 bottBoxes M3
- Retaining rail kitted with 6 bottBoxes M2
- Swivel frame, system width 675 mm
- perfo perforated panel for swivel frame
- Tray, 350 mm deep, for swivel frame 450 mm, kitted with 4 bottBoxes M3
- Bin rail for swivel frame, kitted with 5 bottBoxes M1
- Laminate-coated worktop
- Table load 200 kg
- Total load with attachments 300 kg
- Supplied assembled for versions with hand crank and electric motor

Version	Height adjustment in increments	Height adjuster with hand crank	Height adjuster with electric motor
Dimensions W x D [mm]	1350 x 870	1350 x 870	1350 x 870
total height from - to [mm]	2.035-2.435	2.035-2.435	2.035-2.435
Work height table top from - to [mm]	743-1143	743-1143	743-1143
Dimensions Worktop W x D x H [mm]	1.500 x 750 x 30	1.500 x 750 x 30	1.500 x 750 x 30
Order ref.	41032013.16	41032007.16	41032003.16



194 Drawer dividers can be found on page 68



Compatible bottBoxes from page 226

Single workstations

Complete workstation 4



- 3x vertical profile
- 3x cable duct with brush strips for vertical profile
- 2x overhead arm for vertical profile
- Suspended drawer cabinet W 225 x D 500 x H 500 mm with 2x 200 mm drawers and lock
- Overhead rail with carriage
- LED ECO 42 W strip light with 5 m connecting cable and Schuko plug
- Retaining rail with 3 gang Shuko socket strip, ON/OFF switch and 3 m connection cable with Schuko plug
- perfo perforated panel for system width 900 mm, system height 240 mm
- 2x tray, 200 mm deep, kitted with 6 bottBoxes M2
- 2x perfo perforated panel for system width 450 mm, system height 480 mm
- Laminate-coated worktop
- Table load 200 kg
- Total load with attachments 300 kg
- Supplied assembled for versions with hand crank and electric motor

Version	Height adjustment in increments	Height adjuster with hand crank	Height adjuster with electric motor
Dimensions W x D [mm]	1350 x 870	1350 x 870	1350 x 870
total height from - to [mm]	2.035-2.435	2.035-2.435	2.035-2.435
Work height table top from - to [mm]	743-1143	743-1143	743-1143
Dimensions Worktop W x D x H [mm]	1.500 x 750 x 30	1.500 x 750 x 30	1.500 x 750 x 30
Order ref.	41032012.16	41032006.16	41032002.16

Accessories

Overhead arm

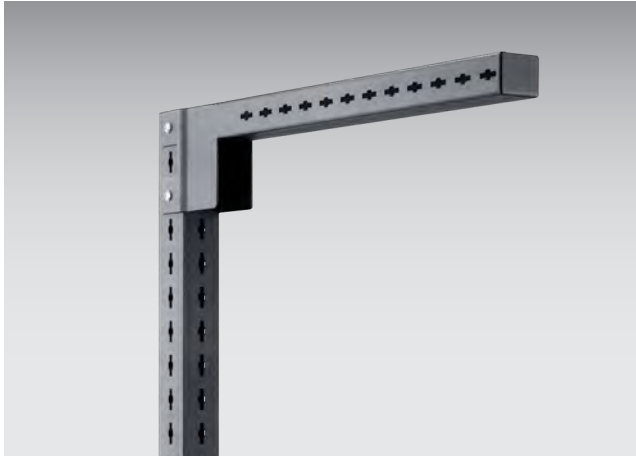

- Installed at the top of the vertical profile
- With avero perforation on the side surfaces
- Cut-out at the transition to the vertical profile for concealed cable guiding
- For attaching avero accessories at a 40 mm depth increment
- Made of conductive powder-coated sheet steel
- Colour: anthracite grey (RAL 7016)
- load capacity 30 kg

Dimensions W x D x H [mm]	57 x 645 x 117
Order ref.	41011010.71

Track rail with runner



- For fastening to the avero overhead arms
- Variable depth adjustment for installation at increments of 40 mm
- Incl. 1 carriage with snap hook
- Stopper element for carriage at both ends
- Carriage load capacity 10 kg
- Overhead rail load capacity 30 kg
- Overhead rail made of conductive powder-coated sheet steel
- Colour: light grey (RAL 7035)

For system width [mm]	675	900	1.350	1.800	Carriage with snap hook	Pair of stoppers
Depth [mm]	30	30	30	30	28	30
Height [mm]	100	100	100	100	98	25
Order ref.	41011179.16	41011026.16	41011027.16	41011028.16	80911002	80802005



196 Drawer dividers can be found on page 68



Compatible bottBoxes from page 226

Accessories

Track rail with runner ESD



- For fastening to the avero overhead arms
- Variable depth adjustment for installation at increments of 40 mm
- Incl. 1 carriage with snap hook
- Stopper element for carriage at both ends
- Carriage load capacity 10 kg
- Overhead rail load capacity 30 kg
- Overhead rail made of conductive powder-coated sheet steel
- Colour: light grey (RAL 7035)
- ESD version with carriage with metal wheels

For system width [mm]	675	900	1.350	1.800	Carriage with snap hook
Depth [mm]	30	30	30	30	22
Height [mm]	100	100	100	100	98
Order ref.	41011179.20	41011026.20	41011027.20	41011028.20	80911007

Accessories

LED strip light / LED ECO strip light

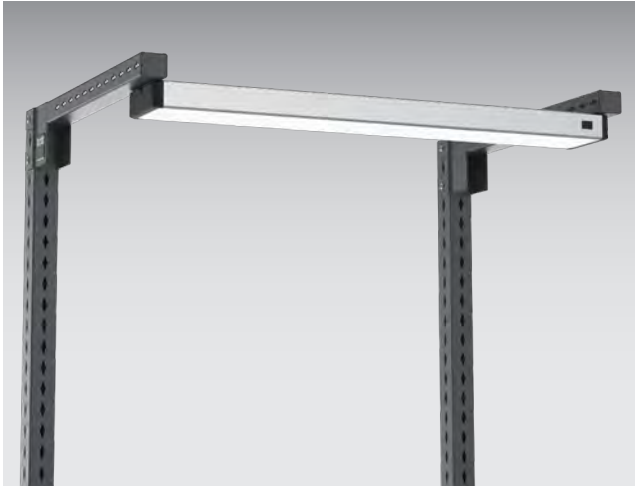

- Particularly energy-efficient and long-lasting thanks to the use of LED technology
- Low glare free thanks to prismatic cover in front of the luminaire
- ON/OFF switch on the housing front
- GST18 power plug connection on the housing rear
- Light colour: daylight white 5700 Kelvin
- Beam angle 90° and colour rendition up to Ra >90
- Infinitely variable dimming possible using separate accessories
- For installation onto avero overhead arms
- Variable depth adjustment in 40 mm increments
- Protection class IP40
- Protection class I
- Colour: anodised aluminium

system width [mm]	900	900	1350	1350	1800	1800
Version	eco	standard	eco	standard	eco	standard
Illumination level at a distance of 100 cm [lx]	1.025	1.717	1.398	2.343	1.655	2.774
Illumination level (maximum value)	1.350	2.262	1.770	2.966	2.027	3.397
Dimensions W x D x H [mm]	900 x 140 x 48	900 x 140 x 48	1350 x 140 x 48	1350 x 140 x 48	1800 x 140 x 48	1800 x 140 x 48
Lamp	LED 26 W	LED 41 W	LED 38 W	LED 60 W	LED 51 W	LED 80 W
Order ref.	50502106	50502103	50502107	50502104	50502108	50502105



Lateral LED light rail



- Particularly energy-efficient and long-lasting thanks to the use of LED technology
- Low glare free thanks to prismatic cover in front of the luminaire
- ON/OFF switch on the housing front
- GST18 power plug connection on the housing rear
- Light colour: daylight white 5700 Kelvin
- Beam angle 90° and colour rendition up to Ra >90
- Infinitely variable dimming possible using separate accessories
- For installation onto avero overhead arms
- Variable depth adjustment in 40 mm increments
- Protection class IP40
- Protection class I
- Colour: anodised aluminium

Illumination level at a distance of 100 cm [lx]	910
Illumination level (maximum value)	1.239
Dimensions W x D x H [mm]	472 x 140 x 48
Lamp	LED 21 W
Order ref.	50502109

Dimming module for 1x LED strip light



- Dimming module for avero LED strip light retrofit
- Suitable for 1x LED strip light
- Ideal for single workstations
- Die-cast aluminium housing with 3 push buttons and 3 m or 5 m connection cable
- Incl. fixings for assembly onto avero vertical profiles and perforated panels
- Protection class IP40
- Beam angle 90° and colour rendition up to Ra >90
- Infinitely variable dimming

Version	Dimming module for 1x LED strip light	Dimming module for 1x LED strip light
Length [m]	3	5
Order ref.	50203014	50203015







.20

Colour combinations: See page 191
 RAL 7035 – light grey RAL 7016 – anthracite grey **ESD-Version available**
 RAL 7035 – light grey

Accessories

Shelf 200 and 350 mm depth

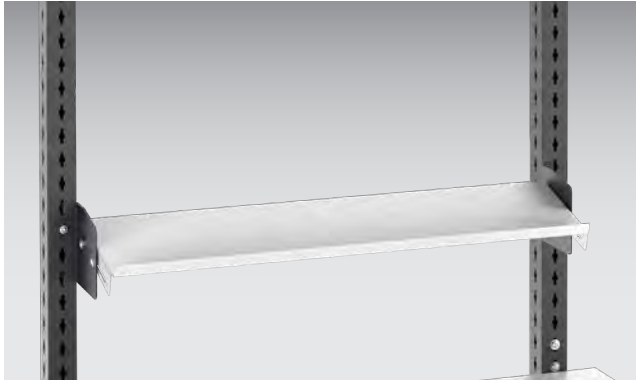

- With hooks for suspending in the avero vertical profile
- Raised lip on one side, 20 mm high
- Shelf tray can optionally be installed with the raised lip on the front or the back
- Inclination continually adjustable by +/- 30°
- Infinitely variable depth adjustment
- Load capacity 60 kg
- Made of conductive powder coated sheet steel
- Colour: light grey (RAL 7035)

For system width [mm]	450	675	900	1350	1800
Dimensions W x D x H [mm]	450 x 200 x 55	675 x 200 x 55	900 x 200 x 55	1350 x 200 x 55	1800 x 200 x 55
Depth adjustment range [mm]	67	67	67	67	67
Order ref.	42105001.20	42105044.20	42105002.20	42105003.20	42105004.20

For system width [mm]	450	675	900	1350	1800
Dimensions W x D x H [mm]	450 x 350 x 55	675 x 350 x 55	900 x 350 x 55	1350 x 350 x 55	1800 x 350 x 55
Depth adjustment range [mm]	217	217	217	217	217
Order ref.	42105005.20	42105045.20	42105006.20	42105007.20	42105008.20

Shelf 650 mm depth



- With hooks for suspending in the avero vertical profile
- Raised lip 25 mm all the way round
- Infinitely variable inclination adjustment by +/- 30°
- Infinitely variable depth adjustment
- Load capacity 60 kg
- Made of conductive powder-coated sheet steel
- Colour: light grey (RAL 7035)

For system width [mm]	450	675	900	1350	1800	
Version						Divider, pack of 5
Dimensions W x D x H [mm]	450 x 650 x 62	675 x 650 x 62	900 x 650 x 62	1350 x 650 x 62	1800 x 650 x 62	17 x 611 x 50
Depth adjustment range [mm]	194	194	194	194	194	
Order ref.	42105013.20	42105046.20	42105014.20	42105015.20	42105016.20	41011225.20



200 Drawer dividers can be found on page 68



Compatible bottBoxes from page 226

Swivel arm with rotatable and inclinable shelf for Euronorm box 400 x 300 mm



- Complete set incl. securing bracket, swivel arm and system fixing
- Shelf tray can be turned through 360° and inclined infinitely variable from 0-45°, fixed with clamp lever
- Safety lip at the front (15 mm)
- 3 hinged joints, 2 swivel arms length 350 and 300 mm
- For fastening to the avero vertical profile
- Load capacity 25 kg
- Made of conductive powder-coated sheet steel
- Colour: light grey (RAL 7035)

Dimensions W x D [mm]	315 x 405	415 x 305
Height of shelf tray safety lip [mm]	15	15
Order ref.	41011059.20	41011060.20

Accessories

Monitor swivel arm

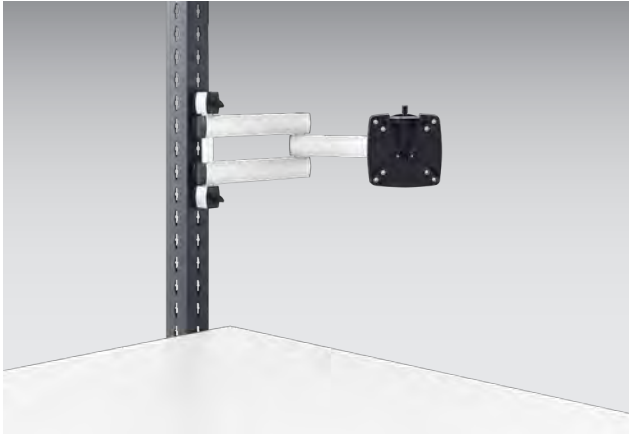

- Reinforced, two-piece articulated arm with a range of 505 mm
- Ball head joint for the flexible tilting and rotation of the monitor
- Removable monitor support plate with VESA 75/100 mount
- For monitors with a weight up to 15 kg
- For fastening to the average vertical profile
- Colour: Anodised aluminium



Dimensions W x D x H [mm]	130 x 500 x 130
Order ref.	41011087
Price £	485.54

Monitor holder, short

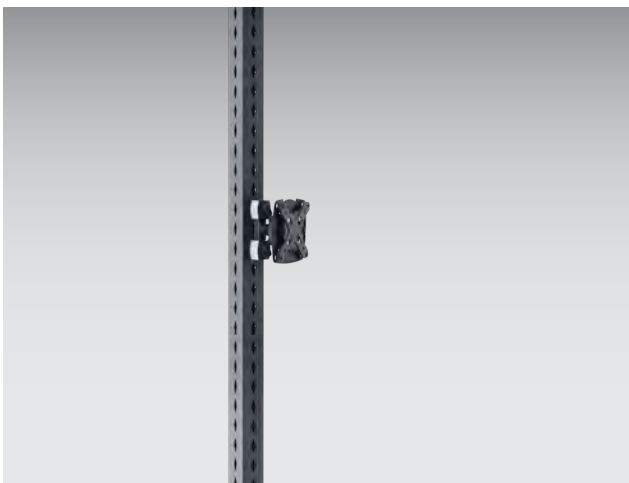

- Ball head joint for the flexible tilting and rotation of the monitor
- Removable monitor support plate with VESA 75/100 mount
- For monitors with a weight up to 15 kg
- For fastening to the average vertical profile
- Colour: Anodised aluminium



Dimensions W x D x H [mm]	130 x 110 x 130
Order ref.	41011086
Price £	300.37



Accessories

perfo monitor holder, short



- Removable monitor support plate with VESA 75/100 mount
- Flexibly tilt and rotate the monitor
- For monitors with a weight up to 10 kg
- For fastening to perfo perforated panels
- Colour: anthracite grey (RAL 7016)



Dimensions W x D x H [mm]	128 x 72 x 172
Order ref.	41011163
Price £	169.72



Colour combinations: See page 191		ESD-Version available	
RAL 7035 – light grey	RAL 7016 – anthracite grey	RAL 7035 – light grey	

Accessories

Keyboard holder for monitor swivel arm and monitor holder



- For fastening to modular support plates
- Tray surface 640 x 200 mm (WxD)
- Colour: light grey (RAL 7035)

Dimensions W x D x H [mm]	640 x 185 x 460
ESD	Yes
Order ref.	42105024.20
Price £	

Swivel arm for keyboard



- Two-piece articulated arm with a range of 505 mm
- Tilting and rotating tray, surface area 640 x 172 mm (WxD)
- Load capacity 10 kg
- Colour: Anodised aluminium/silver



Dimensions W x D x H [mm]	640 x 170 x 20
Order ref.	41011085
Price £	



Accessories

Drawing holder



- Clipboard for documents up to DIN A4 format
- Spring-supported articulated arms
- Height-adjustable rule
- For fastening to the table top or, optionally, to the avero vertical profile
- Colour: light grey (RAL 7035)

version	Drawing holder	Adapter for fastening to avero vertical profile
ESD	No	No
Order ref.	81005004	41011088.19

Display panel system with holder



- Holder system with 10 transparent hinged panels for the dirt-free storage of information sheets
- Suitable for holding DIN A4 sheets in portrait format
- For fastening to the avero vertical profile
- Colour: Stainless-steel holder, red swivelling panel frame
- ESD version with black swivelling panel frame

version	Display panel system with holder	Display panel system with holder
ESD	No	Yes
Order ref.	41011089	41011151

Accessories

Cup holder

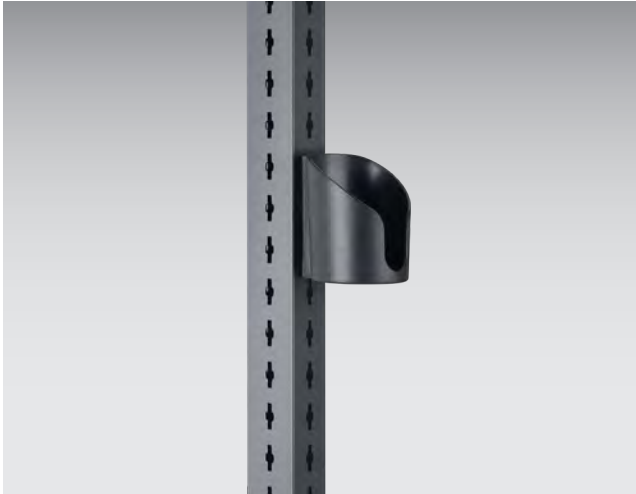

- For mounting on the avero profile or perforated panel
- A closed-floor design for attachment of bottles, cups and containers up to 90 mm in diameter
- An open-floor design for attachment of small power tools
- Material: glass-fibre reinforced plastic
- Incl. fixings for avero profile

Version	Closed bottom	Open bottom
Dimensions W x D x H [mm]	100 x 106 x 118	100 x 106 x 118
Order ref.	14011033	14011031

Bottle holder

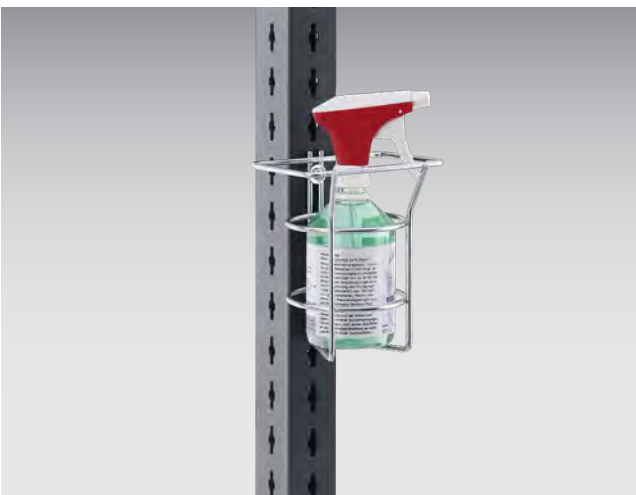

- For holding bottles of up to 96 mm in diameter and Tetra-Pak containers
- For fastening to the avero vertical profile
- Material: zinc-plated steel

Ø [mm]	96
Height [mm]	162
Order ref.	14021058



206 Drawer dividers can be found on page 68



Compatible bottle boxes from page 226

Suspended drawer cabinet ESD



- For installation under avero single workstations, multi-workstations and handling lines
- Optionally with central lock for all drawers or without lock
- Locking cylinder can be changed with cylinder removal key without tools
- Drawers with 100% full extension slide
- Drawer body made of zinc-plated sheet steel
- Load capacity 30 kg per drawer
- Drawer 400 mm high with additional, depth-adjustable small parts tray
- Drawer pull-out lock with variants with lock
- Made of conductive powder-coated sheet steel
- Colour: light grey (RAL 7035)

Version	Without lock	With lock	Without lock	With lock
Drawers [mm]	2x200	2x200	1x400	1x400
Dimensions W x D x H [mm]	225 x 500 x 500	225 x 500 x 500	225 x 500 x 500	225 x 500 x 500
Weight [kg]	16.70	17.30	15.20	15.80
Order ref.	40033013.20	40033014.20	40033015.20	40033016.20

Suspended drawer cabinet ESD



- For installation under avero single workstations, multi-workstations and handling lines
- Optionally with central lock for all drawers or without lock
- Locking cylinder can be changed with cylinder removal key without tools
- Drawers with 100% full extension slide
- Drawer body made of zinc-plated sheet steel
- Load capacity 30 kg per drawer
- Drawer pull-out lock with variants with lock
- Made of conductive powder-coated sheet steel
- Colour: light grey (RAL 7035)

Version	Without lock	With lock	Without lock	With lock
Drawers [mm]	2x100	2x100	1x200	1x200
Dimensions W x D x H [mm]	375 x 500 x 300	375 x 500 x 300	375 x 500 x 300	375 x 500 x 300
Weight [kg]	15.70	16.10	13.00	13.40
Order ref.	40033017.20	40033018.20	40033019.20	40033020.20

Accessories

Suspended drawer cabinet ESD



- For installation under avero single workstations, multi-workstations and handling lines
- Optionally with central lock for all drawers or without lock
- Locking cylinder can be changed with cylinder removal key without tools
- Drawers with 100% full extension slide
- Drawer body made of zinc-plated sheet steel
- Load capacity 30 kg per drawer
- Drawer pull-out lock with variants with lock
- Made of conductive powder-coated sheet steel
- Colour: light grey (RAL 7035)

Version	Without lock	With lock	Without lock	With lock
Drawers [mm]	4x100	4x100	2x200	2x200
Dimensions W x D x H [mm]	375 x 500 x 500	375 x 500 x 500	375 x 500 x 500	375 x 500 x 500
Weight [kg]	26.10	26.70	20.60	21.20
Order ref.	40033021.20	40033022.20	40033023.20	40033024.20



208 Drawer dividers can be found on page 68



Compatible bottBoxes from page 226

Accessories

cubio suspended drawer cabinet



- Intelligent drawer blocking mechanism prevents more than one drawer opening at once
- Mechanical cabinet lock with 5-pin interchangeable cylinder for optional locking system design
- All drawers supplied with full extension slide, 100% extension and 40 mm overextension
- Standard duty slide with 75 kg load capacity
- Ergonomic bow handle with access from above and below
- Colour: light grey (RAL 7035)

Version	1x 150 mm drawer	1x 300 mm drawer	2x 150 mm drawer	2x 75 mm drawer + 1x 150 mm drawer
Drawers [mm]	1x150	1x300	2x150	2x75, 1x150
Dimensions W x D x H [mm]	525 x 525 x 250	525 x 525 x 400	525 x 525 x 400	525 x 525 x 400
Weight [kg]	19.10	20.20	29.30	33.60
Order ref.	40010001.16V	40010126.16V	40010005.16V	40010106.16V

Suspended drawer cabinet cubio ESD



- Intelligent drawer blocking mechanism prevents more than one drawer opening at once
- Mechanical cabinet lock with 5-pin interchangeable cylinder for optional locking system design
- All drawers supplied with full extension slide, 100% extension and 40 mm overextension
- ESD version all drawers with partial extension 93% and 100 kg load capacity
- Standard duty slide with 75 kg load capacity
- Ergonomic bow handle with access from above and below
- Colour: light grey (RAL 7035)

Version	1x 150 mm drawer	1x 300 mm drawer	2x 150 mm drawer	2x 75 mm drawer + 1x 150 mm drawer
Drawers [mm]	1x150	1x300	2x150	2x75, 1x150
Dimensions W x D x H [mm]	525 x 525 x 250	525 x 525 x 400	525 x 525 x 400	525 x 525 x 400
Weight [kg]	18.50	20.20	28.10	31.80
Order ref.	40010001.20V	40010126.20V	40010005.20V	40010106.20V

		ESD	
Colour combinations: See page 191	ESD-Version available		
RAL 7035 – light grey	RAL 7016 – anthracite grey	RAL 7035 – light grey	

Accessories

Footrest

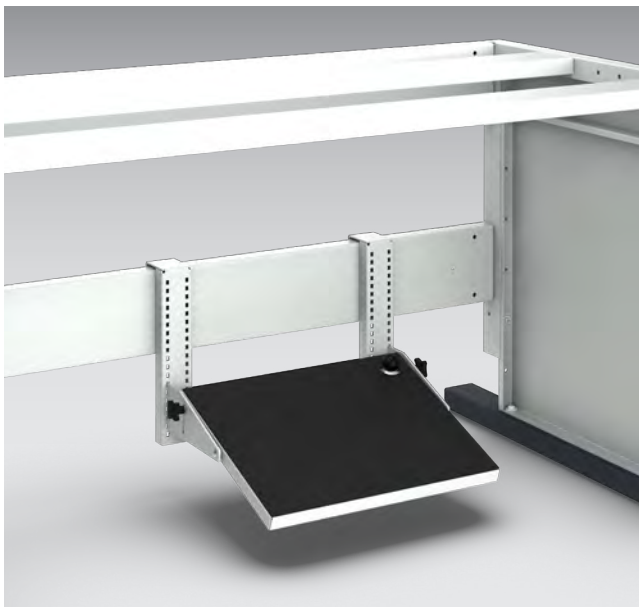

- Ergonomic footrest area 445 x 350 mm (W x D)
- Infinitely-variable foot pedal angle adjustment between 0 to 20
- 210 mm height adjustable in 15 mm increments
- Adjustment range for footrest area is 50-260 mm from the floor
- Meets requirements according to DIN4556
- With slip-resistant, ribbed rubber mat
- Free-standing version with 4 adjustable feet for evening out floor unevenness
- Suspended version with two supports for hanging on bench stringers
- Colour: Light grey metal part (RAL 7035), Black, ribbed, rubber mat
- ESD version with conductive, ribbed, rubber mat, conductive, adjustable feet (freestanding version) and earthing cable (hangable version)



Version	Hangable		Freestanding	
ESD	No	Yes	No	Yes
Order ref.	41402003.16	41402003.20	41402004.16	41402004.20

PC bracket



- For suspending in the stringer of the base frames of single workstations, multiple workstations and transport lines
- Base plate for the attachment of computer housings up to a height of 465 mm
- made of stable, conductive powder-coated sheet steel
- Colour: light grey (RAL 7035)

Dimensions W x D x H [mm]	220 x 544 x 134
Order ref.	41011113.20



210 Drawer dividers can be found on page 68



Compatible bottBoxes from page 226

Accessories

ESD Accessories



- ESD earthing box - (earth bonding point)
- Plastic box with three front snap fastener connections in front, 10 mm diameter
- 1 Mohm safety resistor per snap fastener connection
- 2 m connecting line with ring connector, 4 mm diameter



Version	Earthing box	Wristband with spiral cable
Dimensions W x D x H [mm]	79 x 40 x 25	0 x 0 x 0
Order ref.	50001026.90	50810010



			.20
Colour combinations: See page 191		ESD-Version available	
RAL 7035 – light grey	RAL 7016 – anthracite grey	RAL 7035 – light grey	

Mobile systems

Parts trolley with perfo perforated panels



- For the provision of tools and auxiliary equipment at work
- Robust base frame with swivel castors, diameter 100 mm, 2 with brakes
- Available in 2 heights
- 2 vertical profiles installed in the centre of the base unit
- Assembly with perfo perforated panels on both sides
- Total load bearing capacity 200 kg
- Colour: frame anthracite grey (RAL 7016), perfo perforated panels light grey (RAL 7035)

System width [mm]	675	900	1350
Dimensions W x D x H [mm]	675 x 765 x 1315	900 x 675 x 1315	1350 x 675 x 1315
Dimensions of perforated panels W x D [mm]	621 x 480	848 x 480	1.298 x 480
ESD	No	No	No
Order ref.	41014032.16	41014012.16	41014014.16

System width [mm]	675	900	1350
Dimensions W x D x H [mm]	675 x 765 x 1795	900 x 765 x 1795	1350 x 765 x 1795
Dimensions of perforated panels W x D [mm]	621 x 480	848 x 480	1.298 x 480
ESD	No	No	No
Order ref.	41014031.16	41014011.16	41014013.16



Mobile systems

Parts trolley with perforated panels ESD

System width [mm]	675	900	1350
Dimensions W x D x H [mm]	675 x 675 x 1315	900 x 675 x 1315	1350 x 675 x 1315
Dimensions of perforated panels W x D [mm]	621 x 480	848 x 480	1.298 x 480
ESD	Yes	Yes	Yes
Order ref. ESD	41014032.20	41014012.20	41014014.20

System width [mm]	675	900	1350
Dimensions W x D x H [mm]	675 x 765 x 1795	900 x 765 x 1795	1350 x 765 x 1795
Dimensions of perforated panels W x D [mm]	621 x 480	848 x 480	1.298 x 480
ESD	Yes	Yes	Yes
Order ref. ESD	41014031.20	41014011.20	41014013.20



			.20
Colour combinations: See page 191			
RAL 7035 – light grey	RAL 7016 – anthracite grey	ESD-Version available	
		RAL 7035 – light grey	

System packing table

System packing table with roll dispenser and cutter



- 2 height-adjustable legs
- Table height with assembled foot elements adjustable via 20 mm hole increments
- Melamine-coated worktop, light grey
- Bottom roll dispenser
- Cutter with cut width 1260 mm
- Shelf with 5 division hoops with a 250 mm gap for clearly dividing folding boxes and other shipping and packaging material.
- perfo perforated panel with storage tray and bin rails for bottBoxes
- Colour: anthracite powder-coated (RAL 7016) leg and vertical profile, light grey powder-coated (RAL 7035) perfo perforated panel

Dimensions W x D x H [mm]

1350 x 750 x 2190

Order ref.

41032015.19



System packing table



Workstation design



Team workstations

Workstation design



Joint workstations

- Compact workstations
- Short paths for documentation
- Shared working areas



Flexible yet systematic

- Well thought-out solutions, can be combined with all product areas
- Always suitable for later expansion
- Integration of the power supply
- Turntable for the worktop



Individuality

- Working areas according to individual requirements
- Tailor-made solutions
- Optimally matched to processes and employees



Ergonomics

- Material handling
- Prevention of postural damage to users
- Large selection of work seats
- Floor mats

Team workstations

Computer terminal



- Compact workstation for use in workshops, shipping, QA or production
- Large-volume base cabinet lockable hinged doors and height-adjustable shelf as well as installed 6-fold socket strip with on/off switch
- Recessed monitor attachment with hinged door and viewing window
- Suitable for monitors with up to 600 mm/23" screen size
- integrated keyboard drawer with wrist support and shelf trays which are retractable from the drawer on both sides, W 300 x D 210 mm, for a mouse or for documents
- Central lock for the drawer and the hinged door with viewing window
- Optional rear panel with active ventilation (230V) and filter element
- or passive ventilation via ventilation louvres

Version	With active ventilation (230V)	With passive ventilation	Castor set
Dimensions W x D x H [mm]	800 x 650 x 1700	800 x 650 x 1700	800 x 650 x 125
Order ref.	40032005.**V	40032006.**V	41430077.**

Monitor stand with keyboard drawer



- For mounting on workbenches and cabinets
- Hinged door with viewing window
- Suitable for monitors with up to 600 mm/23" screen size
- Integrated keyboard drawer with wrist support and trays which can be pulled out from the drawer on both sides, W 300 x D 210 mm, for a mouse or for documents
- Central lock for the drawer and the hinged door
- Louvre panels for ventilation

Version	With passive ventilation
Dimensions W x D x H [mm]	800 x 325 x 800
Order ref.	40032007.**V

Team workstations

Team workstations



- Compact workstation for use in workshops, shipping, QA or production
- Lockable base cabinet with hinged door or roller shutter
- Workbench leg with full panelling
- Fully panelled, lockable working area with roller shutter
- Height-adjustable worktop made of laminate faced chipboard, light grey
- Height-adjustable, half depth shelf with integrated LED light integrated halfway down
- 6x gang socket strip with on/off switch
- With adjustable feet to adjust level by 25 mm
- Dimensions: Width 1300 x Depth 650 x Height 2050 mm
- Colours: light grey (RAL 7035) anthracite grey (RAL 7016)

Compact workstation with roller shutter cupboard



Base cabinet spec.	Basic version	Incl. shelf and base shelf infill	With internal drawer 125 mm and sliding shelf
Order ref.	40201025.**	40201027.**	40201029.**

Compact workstation with hinged door cupboard



Base cabinet spec.	Basic version	Incl. shelf and base shelf infill
Order ref.	40201026.**	40201028.**

	.11	.16	.24	.19
Housing:	Top, base and fronts: Details on page 15			
RAL 7035 – light grey	RAL 5010 – gentian blue	RAL 7035 – light grey	RAL 3004 – crimson red	RAL 7016 – anthracite grey

Workstation design

Turntable



- Stainless steel plate with ribbed rubber mat
- ESD version: conductive rubber coating and earthing cable
- Load capacity: 180 kg
- Version with locking mechanism with locking bolt in 45° increments, plate will rotate freely if required

Dimensions Ø x H [mm]	380 x 20				500 x 20			
	No		Yes		No		Yes	
ESD								
Version	without locking mechanism	with locking mechanism	without locking mechanism	with locking mechanism	without locking mechanism	with locking mechanism	without locking mechanism	with locking mechanism
Order ref.	08010036.96	08010035.96	08010056.20	08010055.20	08010034.96	08010009.96	08010054.20	08010053.20

Turntable with foot operation

Dimensions Ø x H [mm]	380 x 20		500 x 20		380 x 155	500 x 155
	Yes	No	Yes	No	–	
Order ref.	08010110.20	08010110.96	08010111.20	08010111.96	08010112.19	08010113.19

Industrial chairs



- Seat height adjustment with high-quality gas strut
- Seat adjustable in inclination and depth, rounded front seat edge for reduced compressive load
- Backrest with permanent contact function, adjustable in height and inclination, reduced backrest width in upper area for optimal freedom of movement
- Seat and backrest upholstery elements optimally adapted to the anatomy of the body, with hard-wearing, breathable cover fabric that can be replaced at any time
- Five-star base, optionally available with sliding bases or castors
- Version with greater height-adjustment range, additionally with height-adjustable, foldable climbing aid
- ESD version with conductive cover fabric, volume-conducting, black plastic parts and conductive swivel castors
- Colour: Aluminium star base black, plastic elements basalt grey, fabric anthracite

Version	Castors		Slides / with climbing aid		Sliding bases	
Height adjustment range [mm]	450-620		590-870		450-620	
ESD	No	Yes	No	Yes	No	Yes
Order ref.	88601062.90	88601065.90	88601064.90	88601067.90	88601063.90	88601066.90

Workstation design

Industrial chairs



- Ergonomically-shaped backrest with an integrated lumbar support for spinal column relief
- The backrest height can be comfortably and easily operated while sitting down
- Comfortable seating space with a rounded-off front seat edge
- Integral foam cushion (PU) for soft, comfortable seating, the highest levels of resistance and ease of cleanliness
- Seat height is infinitely variable from 440-620 mm by means of a self-supporting safety pneumatic spring with a protective cover
- Stable five-foot base
- Colour: black



Version	With braked double castors	With abrasion-resistant plastic sliding bases
Height [mm]	440-620	440-620
Order ref.	88601058.90V	88601059.90V

Team workstations



Standing aid



- Seat height adjustment through high-quality hidden safety gas strut
- Seat tilt adjustment by +/- 9°
- Elevated backrest for ergonomic upright sitting
- Ergonomically shaped, robust and easy-to-clean seat upholstery made of elastic PU foam
- Sturdy 5-star safety star base, diameter 630 mm
- Colour: black



Version	With anti-slip sliding bases
Height [mm]	570-820
Order ref.	88601060.90V

Swivel stools



- Seat height adjustment through high-quality hidden safety gas strut
- Robust and easy-to-clean seat upholstery made of elastic PU foam
- Sturdy 5-star safety star base, diameter 630 mm
- Colour: black



Version	With anti-slip sliding bases
Height [mm]	400-600
Order ref.	88601061.90V

Workstation design

Footrest

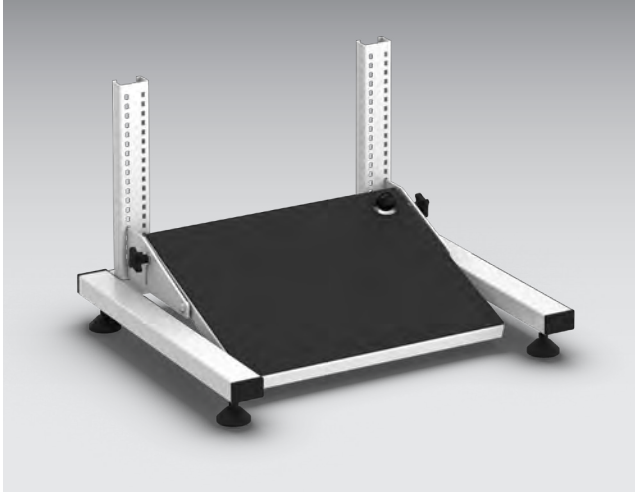

- Ergonomic footrest area 445 x 350 mm (W x D)
- Infinitely-variable foot pedal angle adjustment between 0 to 20
- 210 mm height adjustable in 15 mm increments
- Adjustment range for footrest area is 50-260 mm from the floor
- Meets requirements according to DIN4556
- With slip-resistant, ribbed rubber mat
- Free-standing version with 4 adjustable feet for evening out floor unevenness
- Suspended version with two supports for hanging on bench stringers
- Colour: Light grey metal part (RAL 7035), Black, ribbed, rubber mat
- ESD version with conductive, ribbed, rubber mat, conductive, adjustable feet (freestanding version) and earthing cable (hangable version)

Version	Freestanding	
ESD	No	Yes
Order ref.	41402004.16	41402004.20

Workstation mats

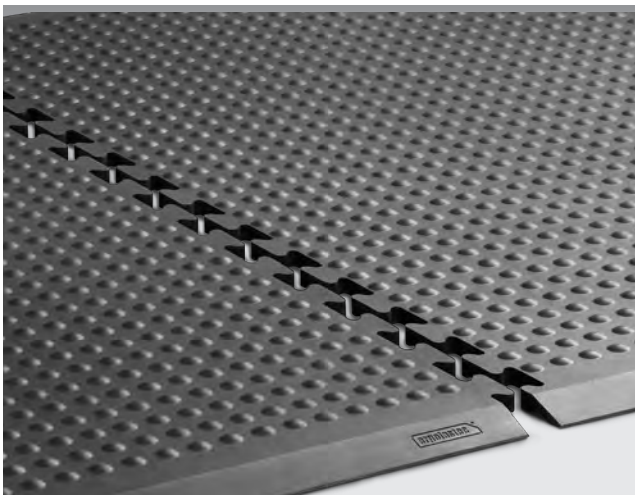

- Ergonomic floor mat for all standing work positions
- Slip-resistant even with dirty surfaces
- Large circular pimples induce muscular activity due to intuitive compensatory movements
- Reduced risk of stumbling due to sloped outer edges
- Very high stability
- Easy to clean with commercial cleansers
- High weight prevents the mat from slipping when laid loosely
- Material: 20 mm SBR (new rubber compound)
- Colour: black

version	Basic set consisting of 2 mats	Extension mat
Dimensions W x D [mm]	2000 x 1350	1000 x 1350
Order ref.	41010140.90V	41010141.90V

Workstation design



bottBox

The standard material box for assembly and logistics



bottBox



Transparent hinged lid

- Prevents content contamination and ensures security during mobile use



Transparent viewing window

- The handle box becomes a storage box with the maximum amount of usable storage thanks to an optional, transparent viewing window



Hopper function

- Viewing window may also be used to create a hopper, thereby creating ergonomical access at the front of the box whilst retaining the maximum usable volume at the rear of the box



Options

- Secure box content separation thanks to reliable divider fixation
- Option to insert business cardsized warehouse and Kanban cards on the rear



Label strip

- Different coloured label strips allow for optional colour coding



7 different sizes

- Wide array of applications thanks to 7 different sizes
- Flexibility thanks to intelligent system dimensions: 2 narrow boxes can be replaced by a wide box
- ESD versions are available

bottBox with viewing window



- Colour: anthracite grey (RAL 7016)
- Label clip
- Inspection window



Version	M1	M2	M2X	M3	M3X	M4	M4X
Dimensions W x D x H [mm]	130 x 100 x 65	130 x 198 x 90	130 x 227 x 165	130 x 298 x 165	130 x 339 x 165	130 x 398 x 165	130 x 451 x 165
Weight [kg]	4.51	7.52	8.16	10.42	5.64	7.16	7.20
Pack of	48	36	24	24	12	12	12
Order ref.	13022053.19	13022054.19	13022173.19	13022055.19	13022174.19	13022057.19	13022176.19



Version	L2X	L3	L3X	L4	L4X	L5
Dimensions W x D x H [mm]	264 x 227 x 165	264 x 298 x 165	264 x 339 x 165	264 x 398 x 165	264 x 451 x 165	264 x 498 x 165
Weight [kg]	5.64	7.99	4.26	4.72	5.28	5.76
Pack of	12	12	6	6	6	6
Order ref.	13022199.19	13022056.19	13022175.19	13022058.19	13022177.19	13022060.19



bottBox without viewing window



- Sturdy, durable shelf box made of polypropylene
- Easy to clean thanks to smooth inner sides
- bottBoxes of the same width are stackable
- Removable label clip for inserting a paper strip (H = 16 mm)
- Optional label clips in 3 further colours available for colour coding
- Ergonomic recessed grip at the front
- Additional grip at the back from size M3
- Strip at the back for suspension on louvred panels
- Integrated label holder (bank card format) located on the back from size M2
- Colour: anthracite grey (RAL 7016)



Version	M1	M2	M2X	M3	M3X	M4	M4X
Dimensions W x D x H [mm]	130 x 100 x 65	130 x 198 x 90	130 x 227 x 165	130 x 298 x 165	130 x 339 x 165	130 x 398 x 165	130 x 451 x 165
Weight [kg]	4.03	7.16	7.68	9.65	5.40	6.36	6.84
Pack of	48	36	24	24	12	12	12
Order ref.	13022045.19	13022046.19	13022163.19	13022047.19	13022164.19	13022049.19	13022166.19



Version	L2X	L3	L3X	L4	L4X	L5
Dimensions W x D x H [mm]	264 x 227 x 165	264 x 298 x 165	264 x 339 x 165	264 x 398 x 165	264 x 451 x 165	264 x 498 x 165
Weight [kg]	6.48	7.19	3.96	4.32	4.98	5.36
Pack of	12	12	6	6	6	6
Order ref.	13022196.19	13022048.19	13022165.19	13022050.19	13022167.19	13022052.19

ESD bottBox without viewing window



- Sturdy, durable shelf box made of polypropylene
- Easy to clean thanks to smooth inner sides
- bottBoxes of the same width are stackable
- Removable label clip for inserting a paper strip (H = 16 mm)
- Optional label clips in 3 further colours available for colour coding
- Ergonomic recessed grip at the front
- Additional grip at the back from size M3
- Strip at the back for suspension in louvred panels
- Integrated label holder (bank card format) located on the back from size M2
- Colour: ESD version black



Version	M1	M2	M3
Dimensions W x D x H [mm]	130 x 100 x 65	130 x 198 x 90	130 x 298 x 165
Weight [kg]	4.51	8.06	10.85
Pack of	48	36	24
Order ref. ESD	13022045.72	13022046.72	13022047.72

bottBox cross dividers

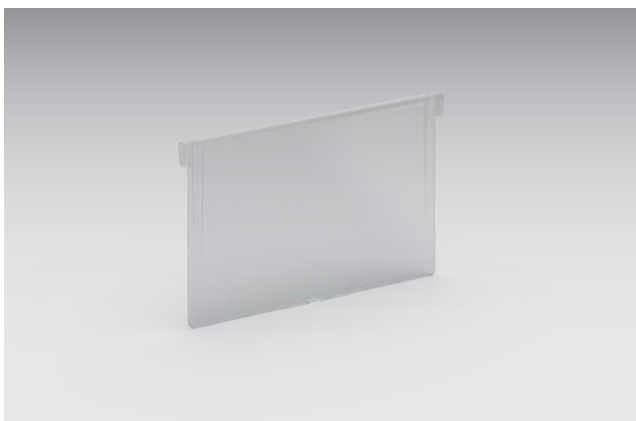

- For dividing the bottBoxes crossways from size M2
- Transparent polycarbonate (PC) makes it easier to see the contents of the rear part of the box
- Colour: transparent
- Pack of 6

For use with bottBox	M2	M2X, M3, M3X, M4, M4X	L3, L3X, L4, L4X, L5
Dimensions W x D x H [mm]	118 x 6 x 68	118 x 6 x 143	252 x 6 x 143
Weight [kg]	0.07	0.28	0.70
Pack of	6	6	6
Order ref.	13022031	13022032	13022033



bottBox viewing window

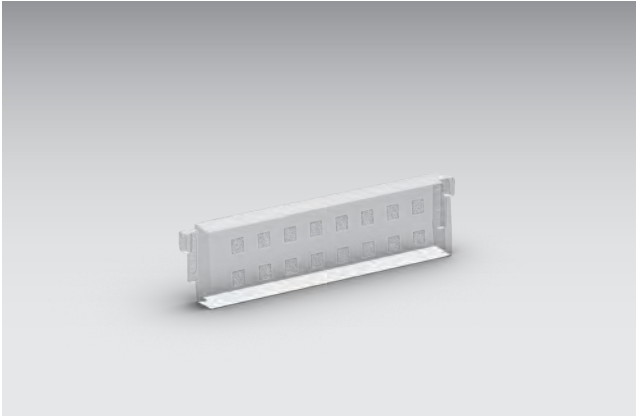

- For insertion on the front of the bottBox
- Turns the shelf box into a full-grade storage box with maximum usable storage volume
- Transparent polycarbonate (PC) makes it easier to see the contents of the box
- From size M2, the viewing window may also be used as a dispensing panel, thereby creating ergonomic access in the front area whilst retaining the maximum usable volume in the rear area
- Colour: transparent
- Pack of 6

For use with bottBox	M1, M2	M2X, M3, M3X, M4, M4X	L2X, L3, L3X, L4, L4X, L5
Dimensions W x D x H [mm]	118 x 12 x 27	118 x 12 x 88	252 x 12 x 88
Weight [kg]	0.06	0.19	0.40
Pack of	6	6	6
Order ref.	13022028	13022029	13022030

bottBox hinged lid



- For closing up bottBoxes
- Material: PC (Polycarbonate) / Colour: transparent

For use with bottBox	M2	M3
Dimensions W x D x H [mm]	117 x 192 x 4	117 x 276 x 4
Weight [kg]	0.36	0.54
Pack of	6	6
Order ref.	13022184	13022185

bottBox hinged lid



- For closing up bottBoxes
- Material: PC (Polycarbonate) / Colour: transparent

For use with bottBox	L3	L4	L5
Dimensions W x D x H [mm]	253 x 274 x 4	253 x 374 x 4	253 x 474 x 4
Weight [kg]	1.27	1.70	2.12
Pack of	6	6	6
Order ref.	13022034	13022035	13022036

bottBox labelling kit



- Document templates for sheets of labels are available free of charge at www.bott.de/service/downloads

Weight [kg]	0.06
Order ref.	61020003



bottBox label clip

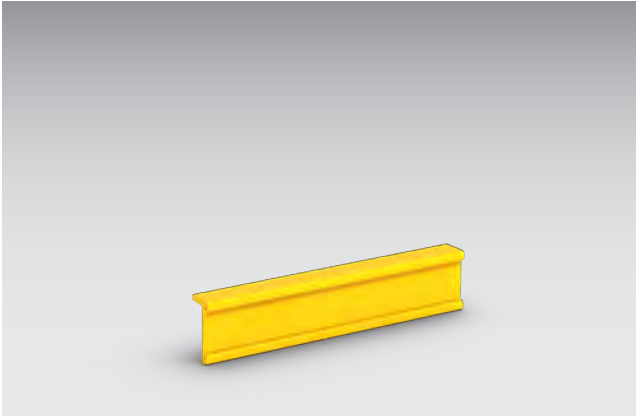

- For colour coding the bottBoxes
- With groove for insertion of a paper strip (H = 16 mm)
- For clipping onto the bottBox body



For use with bottBox	M1, M2, M2X, M3, M3X, M4, M4X	M1, M2, M2X, M3, M3X, M4, M4X	M1, M2, M2X, M3, M3X, M4, M4X	L3, L3X, L4, L4X, L5	L3, L3X, L4, L4X, L5	L3, L3X, L4, L4X, L5
Colour RAL	RAL 1023	RAL 5010	RAL 3001	RAL 1023	RAL 5010	RAL 3001
Colour	Traffic yellow	Gentian blue	Signal red	Traffic yellow	Gentian blue	Signal red
Dimensions W x D x H [mm]	103 x 11 x 20	103 x 11 x 20	103 x 11 x 20	237 x 11 x 20	237 x 11 x 20	237 x 11 x 20
Weight [kg]	0.14	0.14	0.14	0.36	0.36	0.36
Pack of	36	36	36	36	36	36
Order ref.	13022024.12	13022024.11	13022024.04	13022026.12	13022026.11	13022026.04

bottBox label clip

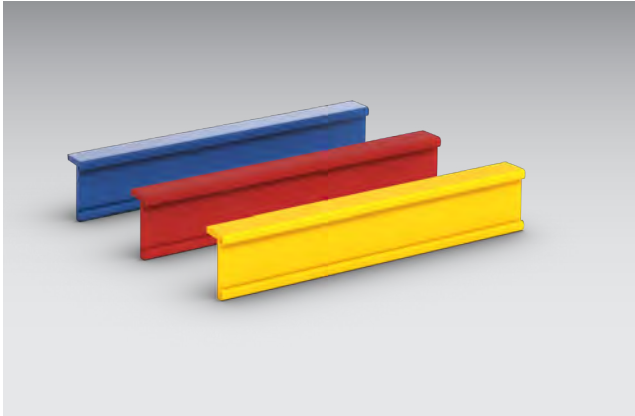

- For colour coding the bottBoxes
- With groove for insertion of a paper strip (H = 16 mm)
- For clipping onto the bottBox body



For use with bottBox	M1, M2, M2X, M3, M3X, M4, M4X	L3, L3X, L4, L4X, L5
Colour RAL	1023/5010/3001	1023/5010/3001
Colour	Mixed	Mixed
Dimensions W x D x H [mm]	103 x 11 x 20	237 x 11 x 20
Weight [kg]	0.14	0.36
Pack of	36	36
Order ref.	13022025	13022027



Aluminium transport cases

Aluminium transport cases



- Load capacity: 35 kg per handle
- Large-sized handles
- Snap lock for attaching padlocks
- Lid with stacking corners with guards
- Lid with rubber sealing profile on all sides
- Compatible with europallets



Weight [kg]	4.28	5.04	5.80	7.70	9.12
Pack of	1	1	1	1	1
Order ref.	02501001	02501002	02501003	02501004	02501005



Euroboxes

Euroboxes



- Resistant to numerous acids and alkalis
- Temperature resistance -20 °C to +60 °C, for a short time also up to +90 °C
- Material: Polypropylene
- Colour: anthracite grey



Width [mm]	200	400	400	400	400
Depth [mm]	300	300	300	300	300
Height [mm]	120	120	175	235	320
Weight [kg]	0.42	0.69	0.95	1.15	1.59
Pack of	1	1	1	1	1
Order ref.	62510019.19V	62510013.19V	62510020.19V	62510014.19V	62510015.19V



Width [mm]	600	600	600	600	1200
Depth [mm]	400	400	400	400	400
Height [mm]	120	175	220	320	171
Weight [kg]	1.17	1.46	1.67	2.52	3.60
Pack of	1	1	1	1	1
Order ref.	62510016.19V	62510021.19V	62510017.19V	62510018.19V	62510036.19V



Euroboxes

Eurobox lids



Width [mm]	600	400
Depth [mm]	400	300
Height [mm]	27	27
Weight [kg]	2.28	1.17
Pack of	3	3
Order ref.	12204065	12204064



Case Systems

Connected worlds of work

Perfect integration with bott
systems

Market standard



Systainer³ connects

With the practical and robust Systainer³ case system, you can efficiently organise and store your tools and equipment. The guide rails inside bott cubio cupboards securely store the Systainer³ cases, allowing them to be easily retrieved.

Systainer³ also integrates just as safely and practically with bott vario3 in-vehicle equipment, allowing you to conveniently carry all equipment from the workshop to the vehicle and from the vehicle to the work site.

The Systainer³ is a widespread industry standard. Fe-stool, Tanos and bott jointly developed this mobility concept in order to provide the perfect service case.

The cases are stackable and can be connected together. In addition, the contents of the Systainer³ can be identified easily with barcoded labels.

Case systems



Case Systems

One system, one standard

- A wide product range and a comprehensive choice of accessories allow optimal solutions to be created to suit any application.
- Simple integration into bott vario3 van racking and bott workshop equipment thanks to side mounts for guide rails.
- Orderly and clear storage of power tools, small parts and consumables enhances working efficiency.
- Maximum flexibility for on & off-site working.

- All size M cases are designed to suit the bott vario3 system width 478-4, size L cases suit the bott vario3 system width 590-5.
- Ideal in combination with the bott vario3 service case sliding shelf.
- Full-extension slides allow efficient and unrestricted access to the contents of the case without having to remove the case from the van racking.

Case systems



Systainer³

- Practical and sturdy system case for the secure and tidy storage and transport of small parts and consumables
- Multifunctional T-LOC: close, open, connect - with just one twist
- Optional labelling via 2 card slots on the front of the case - in standard bank card format
- Can be stacked and connected to all other Systainer products
- Load capacity (single case): 20 kg
- Load capacity (with 2 or more cases connected): 40 kg
- Material: ABS

Systainer³ Organizer

- Transparent lid allows contents to be seen thus minimising search times
- Multifunctional T-LOC: close, open, connect - with just one twist
- Optional labelling via 2 card slots on the front of the case - in standard bank card format
- Can be stacked and connected to many other Systainer products
- Load capacity: 20 kg

bott varioCase

- High-quality service case made from lightweight aluminium or robust sheet steel
- High levels of versatility due to comprehensive range of accessories
- Lid automatically locks when closed preventing accidental spills
- Load capacity: 20 kg

Range of services

Case Systems



Systainer³ M case systems

Systainer³ M empty case for individual assembly



- Practical and sturdy system case for the secure storage and transport of power tools, hand tools, small parts and consumables
- Simple integration in bott vario3 in-vehicle equipment and bott workshop equipment via moulded guide rail slots
- Multifunctional T-LOC: close, open, connect - with just one twist
- 2 integrated label holders on the front of the case (bank card format)
- Can be stacked and linked to all other systainer products
- Load bearing capacity (single): 20 kg
- Load bearing capacity (when connected): 40 kg
- Material: ABS



Description	Systainer ³ M 112	Systainer ³ M 137	Systainer ³ M 187
Version	Carry handle	Carry handle	Carry handle
Assembly	Empty	Empty	Empty
Dimensions W x D x H [mm]	396 x 296 x 112	396 x 296 x 137	396 x 296 x 187
Weight [kg]	1.46	1.56	1.72
Order ref.	72520003.19V	72520004.19V	72520005.19V



Description	Systainer ³ M 237	Systainer ³ M 337	Systainer ³ M 437
Version	Moulded finger grip	Moulded finger grip	Moulded finger grip
Assembly	Empty	Empty	Empty
Dimensions W x D x H [mm]	396 x 296 x 237	396 x 296 x 337	396 x 296 x 437
Weight [kg]	1.96	2.46	2.98
Order ref.	72520006.19V	72520007.19V	72520008.19V

Systainer³ M case systems

Systainer³ M 112 with universal inlay



- Practical and sturdy system case for the secure storage and transport of small parts and consumables
- Equipped with universal inlay with 10 differently sized compartments and lid insert
- Simple integration in bott vario3 in-vehicle equipment and bott workshop equipment via moulded guide rail slots
- Multifunctional T-LOC: close, open, connect - with just one twist
- 2 integrated label holders on the front of the case (bank card format)
- Can be stacked and linked to all other systainer products
- Load bearing capacity (single): 20 kg
- Load bearing capacity (when connected): 40 kg
- Material: ABS

Description	Systainer ³ M 112
Version	Carry handle
Assembly	Universal inlay with 10 compartments
Dimensions W x D x H [mm]	396 x 296 x 112
Weight [kg]	1.70
Order ref.	72520027.19V



Systainer³ M case systems

Systainer³ M with compartment divider set



- Practical and sturdy system case for the secure storage and transport of hand tools, small parts and consumables
- Equipped with compartment divider set for the division of the case into up to 6 equally sized compartments
- Simple integration in bott vario3 in-vehicle equipment and bott workshop equipment thanks to moulded guide rail slots
- Multifunctional T-LOC: close, open, connect - with just one twist
- 2 integrated label holders on the front of the case (bank card format)
- Can be stacked and linked to all other systainer products
- Load bearing capacity (single): 20 kg
- Load bearing capacity (when connected): 40 kg
- Material: ABS



Description	Systainer ³ M 112	Systainer ³ M 137	Systainer ³ M 187
Version	Carry handle	Carry handle	Carry handle
Assembly	Compartment divider set Lid insert	Compartment divider set Lid insert	Compartment divider set Lid insert
Dimensions W x D x H [mm]	396 x 296 x 112	396 x 296 x 137	396 x 296 x 187
Weight [kg]	1.40	1.55	1.65
Order ref.	72520052.19V	72520053.19V	72520054.19V



Description	Systainer ³ M 237	Systainer ³ M 337	Systainer ³ M 437
Version	Moulded finger grip	Moulded finger grip	Moulded finger grip
Assembly	Compartment divider set	Compartment divider set	Compartment divider set
Dimensions W x D x H [mm]	396 x 296 x 237	396 x 296 x 337	396 x 296 x 437
Weight [kg]	2.00	2.30	2.90
Order ref.	72520047.19V	72520048.19V	72520049.19V

Systainer³ M case systems

Systainer³ M 187 with boxes



- Practical and sturdy system case for the secure storage and transport of small parts and consumables
- Equipped with 2 removable box trays with small parts storage boxes
- incl. EPP lid insert
- Simple integration in both vario3 in-vehicle equipment and both workshop equipment thanks to moulded guide rail slots
- Multifunctional T-LOC: close, open, connect - with just one twist
- 2 integrated label holders on the front of the case (bank card format)
- Can be stacked and linked to all other systainer products
- Load bearing capacity (single): 20 kg
- Load bearing capacity (when connected): 40 kg
- Case material: ABS
- Box tray material: powder-coated aluminium



Description	Systainer ³ M 187	Systainer ³ M 187	Systainer ³ M 187
Version	Carry handle	Carry handle	Carry handle
Assembly	18 boxes	25 boxes	32 boxes
Dimensions W x D x H [mm]	396 x 296 x 187	396 x 296 x 187	396 x 296 x 187
Weight [kg]	3.58	3.66	3.78
Order ref.	72520050.19V	72520058.19V	72520059.19V



Systainer³ M case systems

Systainer³ M with die-cut foam insert



- Practical and sturdy system case for the secure storage and transport of hand tools, small parts and consumables
- Equipped with foam cushion, die-cut foam inserts (25mm pitch) and lid pad for designing individual inserts
- Simple integration in bott vario3 in-vehicle equipment and bott workshop equipment via moulded guide rail slots
- Multifunctional T-LOC: close, open, connect - with just one twist
- 2 integrated label holders on the front of the case (bank card format)
- Can be stacked and linked to all other systainer products
- Load bearing capacity (single): 20 kg
- Load bearing capacity (when connected): 40 kg
- Material: ABS



Description	Systainer ³ M 112	Systainer ³ M 137	Systainer ³ M 187
Version	Carry handle	Carry handle	Carry handle
Assembly	1x foam cushion 1x die-cut foam insert 1x lid pad	1x foam cushion 1x die-cut foam insert 1x lid pad	1x foam cushion 3x die-cut foam insert 1x lid pad
Dimensions W x D x H [mm]	396 x 296 x 112	396 x 296 x 137	396 x 296 x 187
Weight [kg]	1.50	1.60	1.70
Order ref.	72520038.19V	72520039.19V	72520040.19V



Description	Systainer ³ M 237	Systainer ³ M 337	Systainer ³ M 437
Version	Moulded finger grip	Moulded finger grip	Moulded finger grip
Assembly	1x foam cushion 5x die-cut foam insert 1x lid pad	1x foam cushion 5x die-cut foam insert 1x lid pad	1x foam cushion 5x die-cut foam insert 1x lid pad
Dimensions W x D x H [mm]	396 x 296 x 237	396 x 296 x 337	396 x 296 x 437
Weight [kg]	2.00	2.30	2.90
Order ref.	72520041.19V	72520042.19V	72520043.19V

Systainer³ M case systems



Case Systems



Systainer³ M case systems

Systainer³ M with spray can insert



- Practical and sturdy system case for the secure storage and transport of spray cans
- Equipped with spray can insert made of EPP for 14 cans with max. diameter 69 mm
- Simple integration in bott vario3 in-vehicle equipment and bott workshop equipment via moulded guide rail slots
- Multifunctional T-LOC: close, open, connect - with just one twist
- 2 integrated label holders on the front of the case (bank card format)
- Can be stacked and linked to all other systainer products
- Load bearing capacity (single): 20 kg
- Load bearing capacity (when connected): 40 kg
- Material: ABS



Description	Systainer ³ M 337	Systainer ³ M 437
Version	Moulded finger grip	Moulded finger grip
Assembly	Spray can insert	Spray can insert
Dimensions W x D x H [mm]	396 x 296 x 337	396 x 296 x 437
Weight [kg]	2.71	3.23
Order ref.	72520029.19V	72520030.19V

Systainer³ M case systems

Systainer³ M with cartridge storage insert



- Practical and sturdy system case for the secure storage and transport of cartridges
- Equipped with cartridge storage insert made of EPP for 22 cartridges with max. diameter 51 mm and 15 cartridge nozzles
- Simple integration in bott vario3 in-vehicle equipment and bott workshop equipment via moulded guide rail slots
- Multifunctional T-LOC: close, open, connect - with just one twist
- 2 integrated label holders on the front of the case (bank card format)
- Can be stacked and linked to all other systainer products
- Load bearing capacity (single): 20 kg
- Load bearing capacity (when connected): 40 kg
- Material: ABS



Description	Systainer ³ M 337	Systainer ³ M 437
Version	Moulded finger grip	Moulded finger grip
Assembly	Cartridge storage insert	Cartridge storage insert
Dimensions W x D x H [mm]	396 x 296 x 337	396 x 296 x 437
Weight [kg]	2.35	2.95
Order ref.	72520031.19V	72520032.19V



Systainer³ M case systems

Systainer³ M with suspension frame



- Practical and sturdy system case for the secure storage and transport of suspended files
- Equipped with suspension frame for suspended files and folders in accordance with DIN 821
- Incl. lid bag for office supplies
- Simple integration in bott vario3 in-vehicle equipment and bott workshop equipment thanks to moulded guide rail slots
- Multifunctional T-LOC: close, open, connect - with just one twist
- 2 integrated label holders on the front of the case (bank card format)
- Can be stacked and linked to all other systainer products
- Load bearing capacity (single): 20 kg
- Load bearing capacity (when connected): 40 kg
- Material: ABS

Description	Systainer ³ M 337
Version	Pull-out aid
Assembly	Suspension frame + lid bag
Dimensions W x D x H [mm]	396 x 296 x 337
Weight [kg]	2.91
Order ref.	72520036.19V

Systainer³ L case systems

Systainer³ L empty case for custom configuration



- Practical and sturdy system case for the secure storage and transport of power tools, hand tools, small parts and consumables
- Simple integration in bott vario3 in-vehicle equipment and bott workshop equipment via moulded guide rail slots
- Multifunctional T-LOC: close, open, connect - with just one twist
- 2 integrated label holders on the front of the case (bank card format)
- Can be stacked and linked to all other systainer products
- Load bearing capacity (single): 20 kg
- Load bearing capacity (when connected): 40 kg
- Material: ABS



Description	Systainer ³ L 137	Systainer ³ L 187	Systainer ³ L 237
Version	Carry handle	Carry handle	Moulded finger grip
Assembly	Empty	Empty	Empty
Dimensions W x D x H [mm]	508 x 296 x 137	508 x 296 x 187	508 x 296 x 237
Weight [kg]	2.06	2.26	2.54
Order ref.	72520009.19V	72520010.19V	72520011.19V



Systainer³ L case systems

Systainer³ L 137 with universal insert



- Practical and sturdy system case for the secure storage and transport of small parts and consumables
- Equipped with universal insert with 6 differently sized compartments and lid insert
- Simple integration in bott vario3 in-vehicle equipment and bott workshop equipment via moulded guide rail slots
- Multifunctional T-LOC: close, open, connect - with just one twist
- 2 integrated label holders on the front of the case (bank card format)
- Can be stacked and linked to many other systainer products
- Load bearing capacity (single): 20 kg
- Load bearing capacity (when connected): 40 kg
- Material: ABS

Description	Systainer ³ L 137
Version	Carry handle
Assembly	Universal insert with 6 compartments
Dimensions W x D x H [mm]	508 x 296 x 137
Weight [kg]	2.00
Order ref.	72520028.19V

Systainer³ L case systems

Systainer³ L with compartment divider set



- Practical and sturdy system case for the secure storage and transport of hand tools, small parts and consumables
- Equipped with compartment divider set for the division of the case into up to 6 equally sized compartments
- Simple integration in bott vario3 in-vehicle equipment and bott workshop equipment thanks to moulded guide rail slots
- Multifunctional T-LOC: close, open, connect - with just one twist
- 2 integrated label holders on the front of the case (bank card format)
- Can be stacked and linked to many other systainer products
- Load bearing capacity (single): 20 kg
- Load bearing capacity (when connected): 40 kg
- Material: ABS



Description	Systainer ³ L 137	Systainer ³ L 187	Systainer ³ L 237
Version	Carry handle	Carry handle	Moulded finger grip
Assembly	Compartment divider set Lid insert	Compartment divider set Lid insert	Compartment divider set
Dimensions W x D x H [mm]	508 x 296 x 137	508 x 296 x 187	508 x 296 x 237
Weight [kg]	1.75	2.00	2.20
Order ref.	72520055.19V	72520056.19V	72520057.19V



Systainer³ L case systems

Systainer³ L 187 with boxes



- Practical and sturdy system case for the secure storage and transport of small parts and consumables
- Equipped with 2 removable box trays with small parts storage boxes
- incl. EPP lid insert
- Simple integration in bott vario3 in-vehicle equipment and bott workshop equipment thanks to moulded guide rail slots
- Multifunctional T-LOC: close, open, connect - with just one twist
- 2 integrated label holders on the front of the case (bank card format)
- Can be stacked and linked to many other systainer products
- Load bearing capacity (single): 20 kg
- Load bearing capacity (when connected): 40 kg
- Case material: ABS
- Box tray material: powder-coated aluminium



Description	Systainer ³ L 187	Systainer ³ L 187	Systainer ³ L 187
Version	Carry handle	Carry handle	Carry handle
Assembly	20 boxes	29 boxes	38 boxes
Dimensions W x D x H [mm]	508 x 296 x 187	508 x 296 x 187	508 x 296 x 187
Weight [kg]	4.58	4.70	4.84
Order ref.	72520051.19V	72520060.19V	72520061.19V

Systainer³ L case systems

Systainer³ L with die-cut foam insert



- Practical and sturdy system case for the secure storage and transport of hand tools, small parts and consumables
- Equipped with foam cushion, die-cut foam inserts (25mm pitch) and lid pad for designing individual inserts
- Simple integration in bott vario3 in-vehicle equipment and bott workshop equipment via moulded guide rail slots
- Multifunctional T-LOC: close, open, connect - with just one twist
- 2 integrated label holders on the front of the case (bank card format)
- Can be stacked and linked to many other systainer products
- Load bearing capacity (single): 20 kg
- Load bearing capacity (when connected): 40 kg
- Material: ABS



Description	Systainer ³ L 137	Systainer ³ L 187	Systainer ³ L 237
Version	Carry handle	Carry handle	Moulded finger grip
Assembly	1x foam cushion 1x die-cut foam insert 1x lid pad	1x foam cushion 3x die-cut foam insert 1x lid pad	1x foam cushion 5x die-cut foam insert 1x lid pad
Dimensions W x D x H [mm]	508 x 296 x 137	508 x 296 x 187	508 x 296 x 237
Weight [kg]	1.85	2.05	3.24
Order ref.	72520044.19V	72520045.19V	72520046.19V



Systainer³ L case systems

Systainer³ L with tool insert



- Practical and sturdy system case for the secure storage and transport of hand tools
- Equipped with tool insert and lid insert / lid bag
- The tool required can be found quickly thanks to the clear storage of the hand tools required
- Simple integration in bott vario3 in-vehicle equipment and bott workshop equipment thanks to moulded guide rail slots
- Multifunctional T-LOC: close, open, connect - with just one twist
- Marking possibility thanks to 2 integrated label holders on the front of the case (bank card format)
- Can be stacked and linked to many other systainer products
- Load bearing capacity (single): 20 kg
- Load bearing capacity (when connected): 40 kg
- Material: ABS



Description	Systainer ³ L 187	Systainer ³ L 237
Version	Carry handle	Pull-out aid
Assembly	Tool insert and lid bag	Tool insert and lid bag
Dimensions W x D x H [mm]	508 x 296 x 187	508 x 296 x 237
Weight [kg]	2.40	2.60
Order ref.	72520034.19V	72520035.19V

Systainer³ organizer M + L case systems

Systainer³ organizer empty case for individual assembly



- Practical and sturdy system case for the secure storage and transport of small parts and consumables
- Transparent lid allows you to see the contents and minimises search times
- Simple integration in bott vario3 in-vehicle equipment and bott workshop equipment via moulded guide rail slots
- Multifunctional T-LOC: close, open, connect - with just one twist
- 2 integrated label holders on the front of the case (bank card format)
- Can be stacked and linked to many other Systainer products
- Load capacity: 20 kg



Description	Systainer ³ Organizer M 89	Systainer ³ Organizer L 89
Assembly	Empty	Empty
Dimensions W x D x H [mm]	396 x 296 x 89	508 x 296 x 89
Weight [kg]	1.60	2.08
Order ref.	72520001.19V	72520002.19V



Systainer³ organizer M + L case systems

Systainer³ organizer with small parts storage boxes



- Practical and sturdy system case for the secure storage and transport of small parts and consumables
- Equipped with small parts storage boxes
- Transparent lid allows you to see the contents and minimises search times
- Simple integration in bott vario3 in-vehicle equipment and bott workshop equipment via moulded guide rail slots
- Multifunctional T-LOC: close, open, connect - with just one twist
- 2 integrated label holders on the front of the case (bank card format)
- Can be stacked and linked to many other systainer products
- Load capacity: 20 kg



Description	Systainer ³ Organizer M 89	Systainer ³ Organizer M 89	Systainer ³ Organizer M 89	Systainer ³ Organizer M 89
Assembly	5 boxes	12 boxes	18 boxes	28 boxes
Dimensions W x D x H [mm]	396 x 296 x 89	396 x 296 x 89	396 x 296 x 89	396 x 296 x 89
Weight [kg]	1.98	2.05	2.39	2.51
Order ref.	72520092.19V	72520021.19V	72520022.19V	72520023.19V



Description	Systainer ³ Organizer L 89	Systainer ³ Organizer L 89	Systainer ³ Organizer L 89	Systainer ³ Organizer L 89
Assembly	7 boxes	13 boxes	20 boxes	33 boxes
Dimensions W x D x H [mm]	508 x 296 x 89	508 x 296 x 89	508 x 296 x 89	508 x 296 x 89
Weight [kg]	2.62	2.65	2.77	2.93
Order ref.	72520093.19V	72520024.19V	72520025.19V	72520026.19V

Systainer³ organizer M + L case systems

Systainer³ organizer with nozzle insert and small parts storage boxes



- Practical and sturdy system case for the secure storage and transport of small parts and consumables
- Equipped with foam inlays and small parts storage boxes for the safe and clear storage of torch nozzles
- Transparent lid allows you to see the contents and minimises search times
- Simple integration in bott vario3 van racking and bott workshop equipment thanks to moulded guide rail slots
- Multifunctional T-LOC: close, open, connect - with just one twist
- Marking possibility thanks to 2 integrated label holders on the front of the case (bank card format)
- Can be stacked and linked to many other systainer products
- Load capacity: 20 kg



Description	Systainer Organizer ³ M 89	Systainer Organizer ³ M 89	Systainer Organizer ³ L 89
Assembly	Nozzle insert for 54 nozzles 2 boxes	Nozzle insert for 81 nozzles 4 boxes	Nozzle insert for 81 nozzles 2 boxes
Dimensions W x D x H [mm]	396 x 296 x 89	396 x 296 x 89	508 x 296 x 89
Weight [kg]	2.00	2.00	2.39
Order ref.	72520082.19V	72520083.19V	72520084.19V



Systainer³ ToolBox M + L case systems

Systainer³ ToolBox



- Practical and sturdy carry box for the secure storage and transport of machines, hand tools, small parts and consumables
- No restriction of the storage space by a lid, therefore also suitable for transporting bulky goods
- Simple integration in bott vario3 in-vehicle equipment and bott workshop equipment thanks to moulded guide rail slots
- Multifunctional T-LOC: close, open, connect with just one twist
- Marking possibility thanks to 2 integrated label holders on the front of the case (bank card format)
- Can be stacked and linked to all other systainer products
- Load bearing capacity (single): 20 kg
- Load bearing capacity (when connected): 40 kg
- Material: ABS



Description	Systainer ³ ToolBox M 137	Systainer ³ ToolBox M 187	Systainer ³ ToolBox M 237
Assembly	Empty	Empty	Empty
Dimensions W x D x H [mm]	396 x 296 x 137	396 x 296 x 187	396 x 296 x 237
Weight [kg]	1.30	1.56	1.70
Order ref.	72520063.19V	72520064.19V	72520065.19V



Description	Systainer ³ ToolBox L 137	Systainer ³ ToolBox L 187	Systainer ³ ToolBox L 237
Assembly	Empty	Empty	Empty
Dimensions W x D x H [mm]	508 x 296 x 137	508 x 296 x 187	508 x 296 x 237
Weight [kg]	1.90	2.09	2.40
Order ref.	72520068.19V	72520069.19V	72520070.19V

Accessories for Systainer³ case systems

Dolly



- For the fast and straightforward transport of several cases
- Suitable for all systainer³ M and L
- Optimum running and stability thanks to large wheels and wheel spacing
- Simple integration in bott vario3 in-vehicle equipment via moulded guide rail slots (width 5 / flat height 175mm)
- 4 swivel castors, front with 2x brake castors
- Wheel diameter: 100 mm
- Load capacity 100 kg
- Colour: anthracite grey



Description	Systainer ³ dolly
Dimensions W x D x H [mm]	508 x 397 x 160
Weight [kg]	2.96
Order ref.	72522029.19V



Accessories for Systainer³ case systems

Holder for dolly



- For the fast, simple and safe storage of the Systainer³ skateboard
- Noise reduced by rubber buffers
- For installation at the side on the bott vario3 SLF frames or perforated panels
- Material: powder-coated aluminium(RAL 7016)



Version	Holder for Systainer ³ dolly
Dimensions W x D x H [mm]	290 x 66 x 439
Net weight kg	0.68
Order ref.	73508025.19V
Final installation [WU]	2.0

Accessories for Systainer³ case systems

Transport trolley with drawer



- Practical transport trolley for the convenient transport of systainer system cases
- Simple movement over steps thanks to large wheels
- Integrated drawer for stowing small parts (load capacity 5 kg)
- With adjustable safety strap
- Dolly and sack truck function
- Suitable for all cases with basic dimensions 400 x 300 mm
- Wheel diameter front: 75 mm
- Wheel diameter rear: 200 mm
- Load capacity 100 kg

Description	Transport trolley with drawer
Dimensions W x D x H [mm]	600 x 440 x 1100
Weight [kg]	6.50
Order ref.	72522030.90V

Case Systems



Options



Accessories for Systainer³ case systems

Labelling kit



- For the clean and orderly labelling of the cases
- Reduces search times and increases efficiency
- Suitable for all systainer³ M and L
- For use in the integrated label holders on the front of the case
- Comprising 20 transparent cards and 2 labelling sheets with 10 paper cards each for tearing off

Description	Labelling kit
Dimensions W x D x H [mm]	86 x 1 x 54
Weight [kg]	0.09
Order ref.	72522038

varioCase M case systems

varioCase M empty



- Lightweight and high-quality service case for customised configuration
- Simple integration in bott vario3 in-vehicle equipment and bott workshop equipment via moulded guide rail slots
- Lid automatically locks when closed preventing accidental spills
- Load capacity: 20 kg
- Material: anodised aluminium



Description	varioCase M 84	varioCase M 135
Assembly	Empty	Empty
Dimensions W x D x H [mm]	396 x 337 x 84	396 x 337 x 135
Weight [kg]	1.39	1.64
Order ref.	72511001.97V	72511003.97V



varioCase M case systems

varioCase M empty



- Sturdy and high-quality service case for customised configuration
- Simple integration in bott vario3 in-vehicle equipment and bott workshop equipment via moulded guide rail slots
- Lid automatically locks when closed preventing accidental spills
- Load capacity: 20 kg
- Material: powder coated sheet steel
- Colour: anthracite grey (RAL 7016)



Description	varioCase M 84	varioCase M 135
Assembly	Empty	Empty
Dimensions W x D x H [mm]	396 x 337 x 84	396 x 337 x 135
Weight [kg]	2.75	3.16
Order ref.	72511005.19V	72511007.19V

varioCase M case systems

varioCase M with dividers and cross dividers



- Lightweight and high-quality service case equipped with dividers and cross dividers
- For the tidy and clear storage of tools and consumables
- Simple integration in both vario3 in-vehicle equipment and both workshop equipment via moulded guide rail slots
- Lid automatically locks when closed preventing accidental spills
- Load capacity: 20 kg
- Material: anodised aluminium



Description	varioCase M 84	varioCase M 135
Assembly	2x divider / 5x cross divider	2x divider / 5x cross divider
Dimensions W x D x H [mm]	396 x 337 x 84	396 x 337 x 135
Weight [kg]	1.82	2.34
Order ref.	72511013.97V	72511015.97V



varioCase M case systems

varioCase M with dividers and cross dividers



- Sturdy and high-quality service case equipped with dividers and cross dividers
- For the tidy and clear storage of tools and consumables
- Simple integration in bott vario3 in-vehicle equipment and bott workshop equipment via moulded guide rail slots
- Lid automatically locks when closed preventing accidental spills
- Load capacity: 20 kg
- Material: powder coated sheet steel
- Colour: anthracite grey (RAL 7016)



Description	varioCase M 84	varioCase M 135
Assembly	2x divider / 5x cross divider	2x divider / 5x cross divider
Dimensions W x D x H [mm]	396 x 337 x 84	396 x 337 x 135
Weight [kg]	3.18	3.86
Order ref.	72511014.19V	72511016.19V

varioCase M case systems

varioCase M 84 with assortments of boxes



- Lightweight and high-quality service case equipped with small parts storage boxes
- For the tidy and clear storage of small parts and consumables
- Simple integration in both vario3 in-vehicle equipment and both workshop equipment via moulded guide rail slots
- Lid automatically locks when closed preventing accidental spills
- Load capacity: 20 kg
- Material: anodised aluminium



Description	varioCase M 84	varioCase M 84	varioCase M 84	varioCase M 84
Assembly	11 boxes	17 boxes	24 boxes	32 boxes
Dimensions W x D x H [mm]	396 x 337 x 84	396 x 337 x 84	396 x 337 x 84	396 x 337 x 84
Weight [kg]	1.93	1.99	2.12	2.20
Order ref.	72511017.97V	72511018.97V	72511020.97V	72511021.97V



varioCase M case systems

varioCase M 84 with assortments of boxes



- Sturdy and high-quality service case equipped with small parts storage boxes
- For the tidy and clear storage of small parts and consumables
- Simple integration in bott vario3 in-vehicle equipment and bott workshop equipment via moulded guide rail slots
- Lid automatically locks when closed preventing accidental spills
- Load capacity: 20 kg
- Material: powder coated sheet steel
- Colour: anthracite grey (RAL 7016)



Description	varioCase M 84
Assembly	17 boxes
Dimensions W x D x H [mm]	396 x 337 x 84
Weight [kg]	3.34
Order ref.	72511019.19V

varioCase M case systems

varioCase M 135 with assortments of boxes



- Lightweight and high-quality service case equipped with small parts storage boxes
- For the tidy and clear storage of small parts and consumables
- Ample storage space via integrated second storage level with box tray
- Simple integration in both vario3 in-vehicle equipment and both workshop equipment via moulded guide rail slots
- Lid automatically locks when closed preventing accidental spills
- Load capacity: 20 kg
- Material: anodised aluminium



Description	varioCase M 135
Assembly	33 boxes with box tray
Dimensions W x D x H [mm]	396 x 337 x 135
Weight [kg]	3.24
Order ref.	72511022.97V



varioCase M case systems

varioCase M 84 with nozzle insert



- Lightweight and high-quality service case equipped with nozzle insert and small parts storage boxes
- For the safe and clear storage of torch nozzles
- Simple integration in bott vario3 in-vehicle equipment and bott workshop equipment via moulded guide rail slots
- Lid automatically locks when closed preventing accidental spills
- Load capacity: 20 kg
- Material: anodised aluminium



Description	varioCase M 84
Assembly	Nozzle insert and 2 small parts storage boxes
Dimensions W x D x H [mm]	396 x 337 x 84
Weight [kg]	2.28
Order ref.	72511029.97V

varioCase L case systems

varioCase L empty



- Lightweight and high-quality service case for customised configuration
- Simple integration in bott vario3 in-vehicle equipment and bott workshop equipment via moulded guide rail slots
- Lid automatically locks when closed preventing accidental spills
- Load capacity: 20 kg
- Material: anodised aluminium



Description	varioCase L 84	varioCase L 135
Assembly	Empty	Empty
Dimensions W x D x H [mm]	508 x 337 x 84	508 x 337 x 135
Weight [kg]	1.65	1.94
Order ref.	72511002.97V	72511004.97V



varioCase L case systems

varioCase L empty



- Sturdy and high-quality service case for customised configuration
- Simple integration in bott vario3 in-vehicle equipment and bott workshop equipment via moulded guide rail slots
- Lid automatically locks when closed preventing accidental spills
- Load capacity: 20 kg
- Material: powder coated sheet steel
- Colour: anthracite grey (RAL 7016)



Description	varioCase L 84	varioCase L 135
Assembly	Empty	Empty
Dimensions W x D x H [mm]	508 x 337 x 84	508 x 337 x 135
Weight [kg]	3.42	3.91
Order ref.	72511006.19V	72511008.19V

varioCase L case systems

varioCase L with dividers and cross dividers



- Lightweight and high-quality service case equipped with dividers and cross dividers
- For the tidy and clear storage of tools and consumables
- Simple integration in both vario3 in-vehicle equipment and both workshop equipment via moulded guide rail slots
- Lid automatically locks when closed preventing accidental spills
- Load capacity: 20 kg
- Material: anodised aluminium



Description	varioCase L 84	varioCase L 135
Assembly	3x divider / 6x cross divider	3x divider / 6x cross divider
Dimensions W x D x H [mm]	508 x 337 x 84	508 x 337 x 135
Weight [kg]	2.26	2.91
Order ref.	72511009.97V	72511011.97V



varioCase L case systems

varioCase L with dividers and cross dividers



- Sturdy and high-quality service case equipped with dividers and cross dividers
- For the tidy and clear storage of tools and consumables
- Simple integration in bott vario3 in-vehicle equipment and bott workshop equipment via moulded guide rail slots
- Lid automatically locks when closed preventing accidental spills
- Load capacity: 20 kg
- Material: powder coated sheet steel
- Colour: anthracite grey (RAL 7016)



Description	varioCase L 84	varioCase L 135
Assembly	3x divider / 6x cross divider	3x divider / 6x cross divider
Dimensions W x D x H [mm]	508 x 337 x 84	508 x 337 x 135
Weight [kg]	4.02	4.88
Order ref.	72511010.19V	72511012.19V

varioCase L case systems

varioCase L 84 with assortments of boxes



- Lightweight and high-quality service case equipped with small parts storage boxes
- For the tidy and clear storage of small parts and consumables
- Simple integration in both vario3 in-vehicle equipment and both workshop equipment via moulded guide rail slots
- Lid automatically locks when closed preventing accidental spills
- Load capacity: 20 kg
- Material: anodised aluminium



Description	varioCase L 84	varioCase L 84	varioCase L 84	varioCase L 84
Assembly	12 boxes and tool compartment	17 boxes and tool compartment	24 boxes and tool compartment	32 boxes and tool compartment
Dimensions W x D x H [mm]	508 x 337 x 84	508 x 337 x 84	508 x 337 x 84	508 x 337 x 84
Weight [kg]	2.30	2.38	2.52	2.59
Order ref.	72511023.97V	72511024.97V	72511026.97V	72511027.97V



varioCase L case systems

varioCase L 84 with assortments of boxes



- Sturdy and high-quality service case equipped with small parts storage boxes
- For the tidy and clear storage of small parts and consumables
- Simple integration in bott vario3 in-vehicle equipment and bott workshop equipment via moulded guide rail slots
- Lid automatically locks when closed preventing accidental spills
- Load capacity: 20 kg
- Material: powder coated sheet steel
- Colour: anthracite grey (RAL 7016)



Description	varioCase L 84
Assembly	17 boxes and tool compartment
Dimensions W x D x H [mm]	508 x 337 x 84
Weight [kg]	4.15
Order ref.	72511025.19V

varioCase L case systems

varioCase L 135 with assortments of boxes



- Lightweight and high-quality service case equipped with small parts storage boxes
- For the tidy and clear storage of small parts and consumables
- Ample storage space thanks to second storage level with box tray
- Simple integration in both vario3 in-vehicle equipment and both workshop equipment via moulded guide rail slots
- Lid automatically locks when closed preventing accidental spills
- Load capacity: 20 kg
- Material: anodised aluminium



Description	varioCase L 135
Assembly	34 boxes with box tray and tool compartment
Dimensions W x D x H [mm]	508 x 337 x 135
Weight [kg]	3.88
Order ref.	72511028.97V



varioCase L case systems

varioCase L 84 with nozzle insert



- Lightweight and high-quality service case equipped with nozzle insert and small parts storage boxes
- For the safe and clear storage of oil burner nozzles
- Simple integration in bott vario3 in-vehicle equipment and bott workshop equipment via moulded guide rail slots
- Lid automatically locks when closed preventing accidental spills
- Load capacity: 20 kg
- Material: anodised aluminium



Description	varioCase L 84
Assembly	Nozzle insert, 2 small parts storage boxes and tool compartment
Dimensions W x D x H [mm]	508 x 337 x 84
Weight [kg]	2.68
Order ref.	72511030.97V

perfo

Ordered workspace

Quick access to tools and
small parts

One system - the original



An orderly overview of tools and equipment

bott perfo is a flexible open storage for tools, small parts and consumables, allowing for easy and quick access.

The range incorporates, wall panels, in-cupboard systems, mobile trolleys and free-standing solutions. bott perfo also integrates perfectly with with cubio workbenches, to create individual workstations, there's something for everyone.

The durable powder-coated perfo panels provide sturdy and long-term protection, ideal for regular use and storing heavy items. bott perfo integrates with a wide range of accessories, hooks and tool holders, supporting LEAN and 5S initiatives.

Range of services

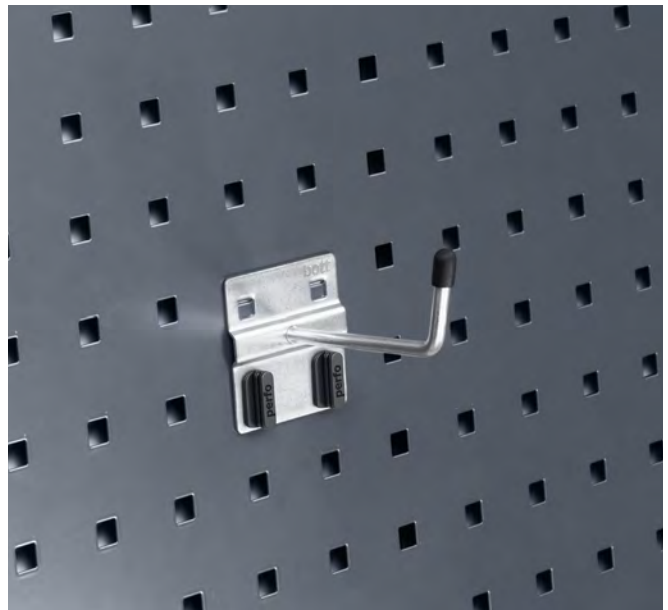
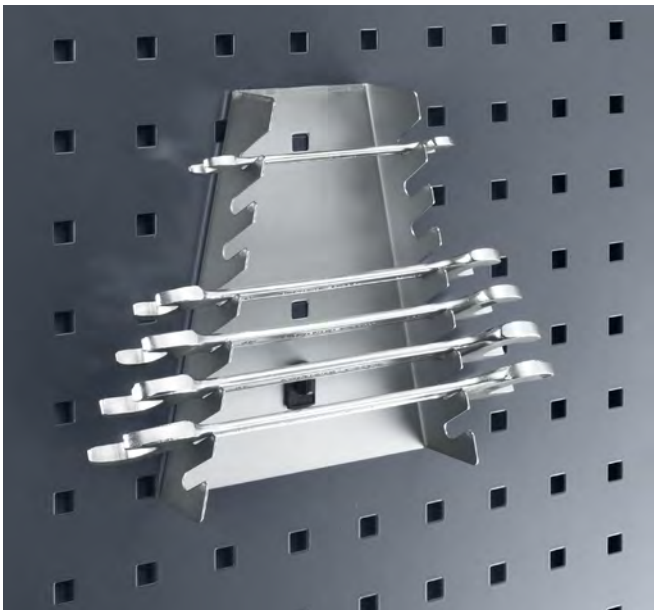

perfo

Use

- Wall mounting
- Workbench mounting
- perfo racks
- perfo trolleys
- perfo wall-mounted cabinets
- cubio cabinets
- Vehicle side lining
- bott vario end frames
- Vehicle bulkheads

Component parts

- Zinc plated, for long-lasting protection and sturdiness in use
- Additional welding point on the back of the holder for high stability and load capacity
- Special fastening clip prevents the unintentional detaching of the hook

Range of services



	Individual planning
	Custom solutions available

	Fast, dependable delivery times
	Availability guarantee

	ISO-certified 9001:2008 14001:2009
	International availability

Kits

perfo panels with hook kit



- Kit 16-piece
- 1 perfo perforated panel width 457 x height 990 mm
- 5 Hooks D 75 mm
- 5 Hooks D 100 mm
- 5 Hooks D 150 mm
- 1 perfo spanne

Dimensions W x H [mm]	990 x 457
Weight [kg]	5.00
Order ref.	14030154.**V

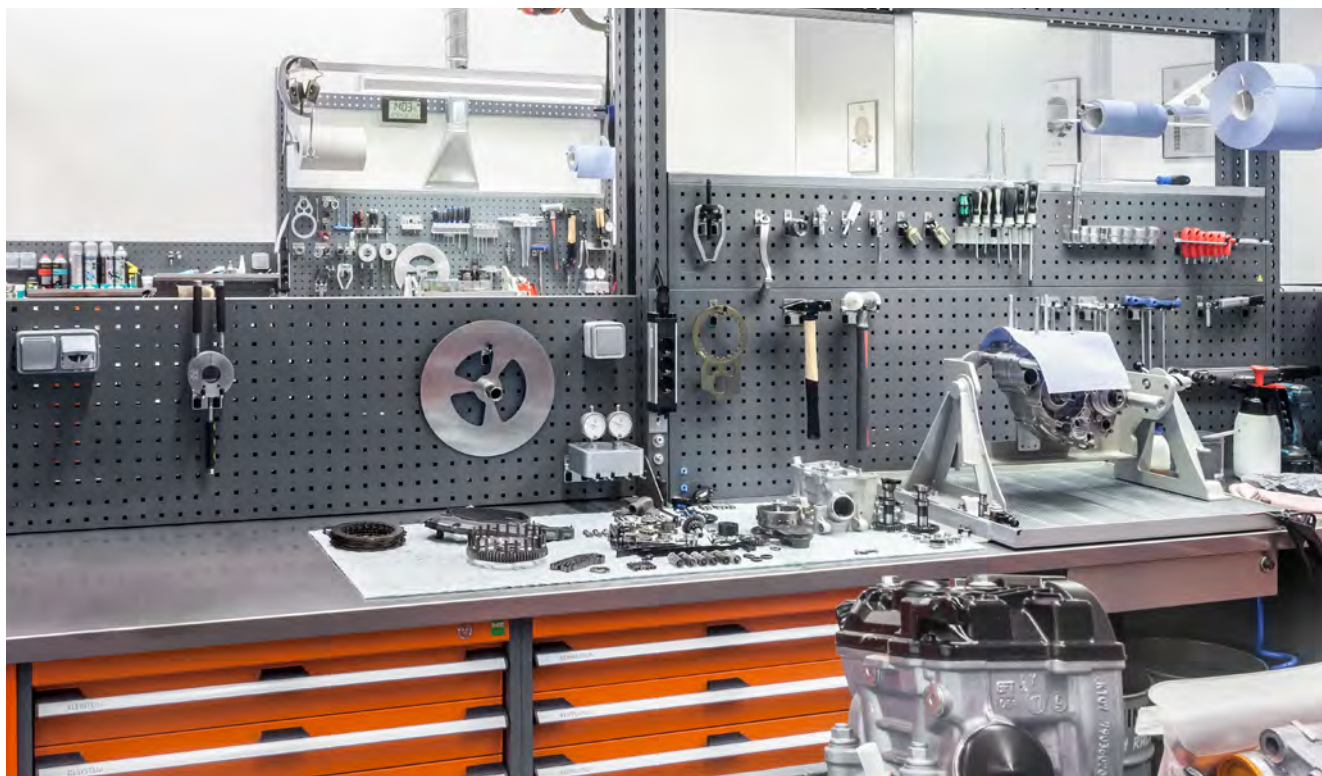

perfo, the original

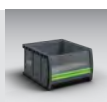

286 Compatible bottBoxes from page 226

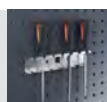

perfo hooks and holders from page 299

perfo panels with hook kit

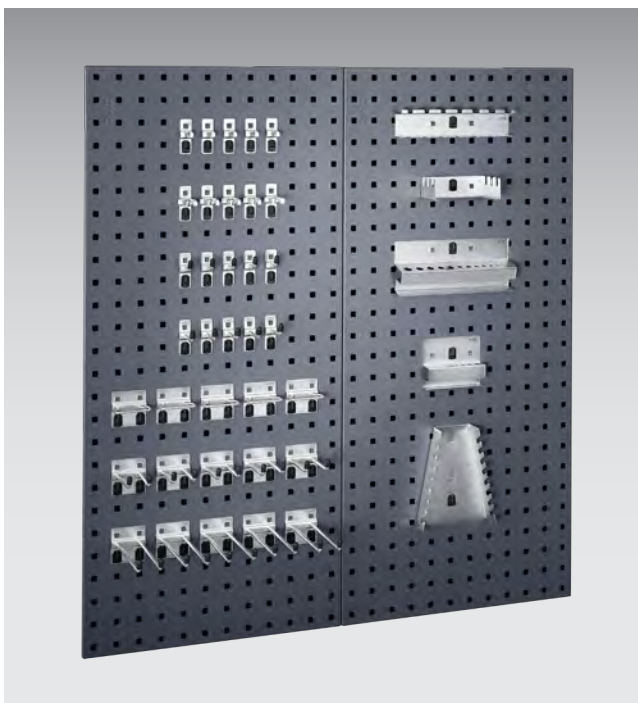

- Kit 42-piece
- 2 perfo panels width 457 x height 990 mm
- 5 Hooks D 25 mm
- 5 Hooks D 50 mm
- 5 Double hooks D 75 mm
- 5 Double hooks D 150 mm
- 5 U-Holder 60 x 20 mm
- 5 Spring clip Ø 13 mm
- 5 Spring clip Ø 25 mm
- 1 Spanner holder
- 1 Saw holder
- 1 Screwdriver holder
- 1 Allen key holder
- 1 Drill holder

Dimensions W x H [mm]	990 x 457
Weight [kg]	10.00
Order ref.	14030155.**V

perfo louvred panels with 24 bottBoxes



- perfo louvred panel kit consisting of: 2 panels and 24 bottBoxes
- Dimensions bottBoxes W x D x H: 130 x 198 x 90 mm

Quantity bottBoxes	24 x M2
Dimensions W x D x H [mm]	914 x 19 x 495
Weight [kg]	8.97
Order ref.	14030200.**

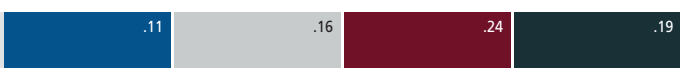

perfo panels: Details on page 15

RAL 5010 – gentian blue RAL 7035 – light grey RAL 3004 – crimson red RAL 7016 – anthracite grey

Kits with bottBoxes

perfo louvred panels with 51 bottBoxes



- perfo louvred panel kit consisting of: 3 panels and 51 bottBoxes
- Dimensions bottBoxes:
- M2 W x D x H: 130 x 198 x 90 mm
- M3 W x D x H: 130 x 298 x 165 mm
- L3 W x D x H: 264 x 298 x 165 mm

Quantity bottBoxes	27 x M2, 21 x M3, 3 x L3
Dimensions W x D x H [mm]	1371 x 19 x 990
Weight [kg]	26.33
Order ref.	14030201.**

perfo louvred panels with 54 bottBoxes



- perfo louvred panel kit consisting of: 2 panels and 54 bottBoxes
- Dimensions bottBoxes W x D x H: 130 x 198 x 90 mm

Quantity bottBoxes	54 x M2
Dimensions W x D x H [mm]	914 x 19 x 1486
Weight [kg]	23.19
Order ref.	14030199.**

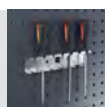

Perforated and louvred panels

perfo perforated panels

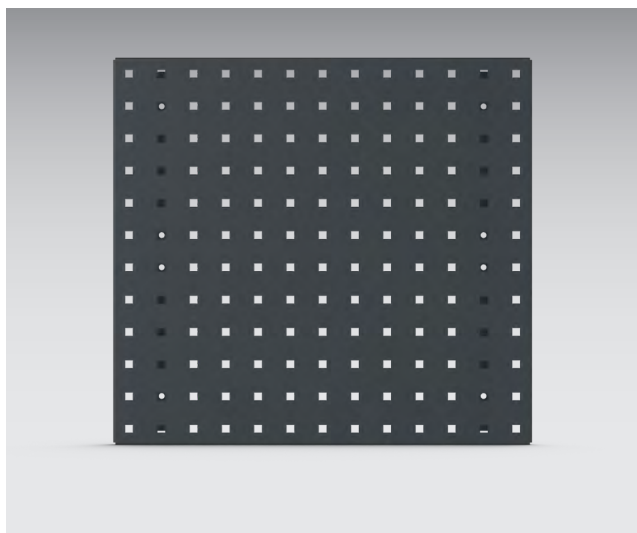

- Powder coated perforated steel panels for use with perfo hooks and holders
- High rigidity due to side folds
- Additional reinforcements on the back
- Perforation: 9.2 x 9.2 mm, hole spacing: 38.1 mm
- Accessories lock into place with the supplied clip
- Hole spacing is maintained across the panel edge in multiple panel installations

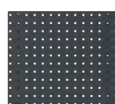

Design	perfo	perfo perforated panel	perfo perforated panel	perfo perforated panel
Dimensions W x H [mm]	495 x 457	525 x 457	650 x 457	750 x 457
Weight [kg]	2.18	2.51	3.05	3.40
Order ref.	14025115.**	14025391.**	14025392.**	14025393.**



Design	perfo perforated panel	perfo	perfo perforated panel	perfo perforated panel
Dimensions W x H [mm]	800 x 457	990 x 457	1050 x 457	1300 x 457
Weight [kg]	3.73	4.07	4.28	5.31
Order ref.	14025394.**	14025117.**	14025395.**	14025396.**



Design	perfo	perfo
Dimensions W x H [mm]	1486 x 457	1981 x 457
Weight [kg]	5.92	7.87
Order ref.	14025118.**	14025119.**

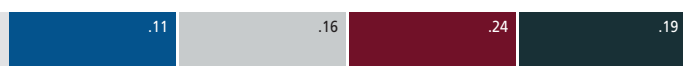

perfo panels: Details on page 15

RAL 5010 – gentian blue RAL 7035 – light grey RAL 3004 – crimson red RAL 7016 – anthracite grey

Perforated and louvred panels

perfo rails

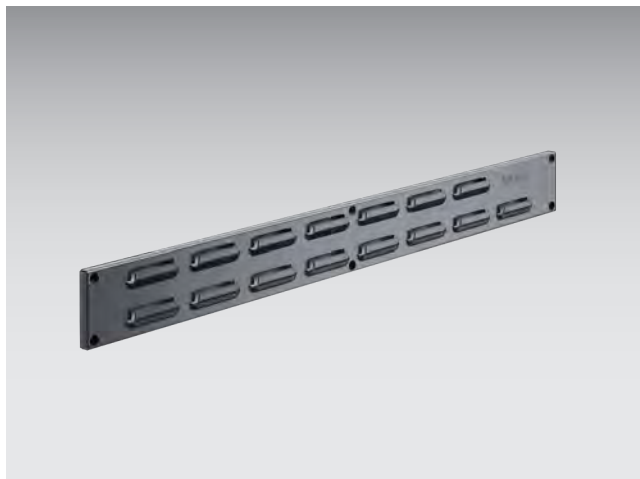

- Symmetrically embossed sheet steel strips for attaching perfo holders and plastic storage bins
- Width 650 mm, also suitable for side-mounting to workbench leg or workbench panel



Design	Louvred form	Louvred form
Dimensions W x H [mm]	650 x 76	990 x 76
Weight [kg]	0.60	0.80
Order ref.	14025285.**V	14025283.**V



Design	Perforation	Perforation
Dimensions W x H [mm]	650 x 76	990 x 76
Weight [kg]	0.60	0.85
Order ref.	14025284.**V	14025282.**V

perfo, the original



290 Compatible bottBoxes from page 226

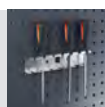

perfo hooks and holders from page 299

Perforated and louvred panels

perfo louvred panels



- Embossed sheet steel panels for attaching plastic bins and tool blocks
- High rigidity due to side folds
- Additional reinforcements on the back

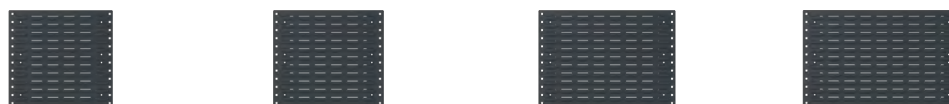

Design	Horizontal	Horizontal	Horizontal	Horizontal
Dimensions W x H [mm]	495 x 457	525 x 457	650 x 457	750 x 457
Weight [kg]	2.13	2.24	2.67	3.03
Order ref.	14025137.**	14025397.**	14025398.**	14025399.**

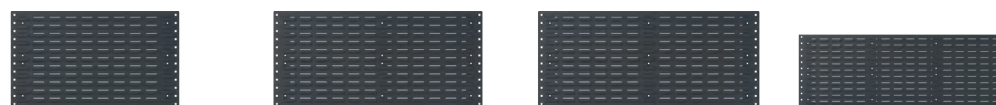

Design	Horizontal	Horizontal	Horizontal	Horizontal
Dimensions W x H [mm]	800 x 457	990 x 457	1050 x 457	1300 x 457
Weight [kg]	3.20	4.03	4.24	5.27
Order ref.	14025400.**	14025139.**	14025401.**	14025402.**



Design	Horizontal	Horizontal
Dimensions W x H [mm]	1486 x 457	1981 x 457
Weight [kg]	5.92	7.87
Order ref.	14025140.**	14025141.**



Design	Vertical	Vertical	Vertical	Vertical
Dimensions W x H [mm]	457 x 495	457 x 990	457 x 1486	457 x 1981
Weight [kg]	1.83	3.57	5.32	6.96
Order ref.	14025147.**	14025148.**	14025149.**	14025240.**

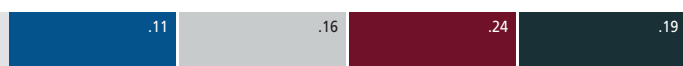

perfo panels: Details on page 15

RAL 5010 – gentian blue RAL 7035 – light grey RAL 3004 – crimson red RAL 7016 – anthracite grey

Kits

perfo hook kit 11-piece



- 5 Hooks D 75 mm
- 5 Double hooks D 75 mm
- 1 Spanner holder

Weight [kg]	1.00
Order ref.	14030064

perfo hook kit 13-piece

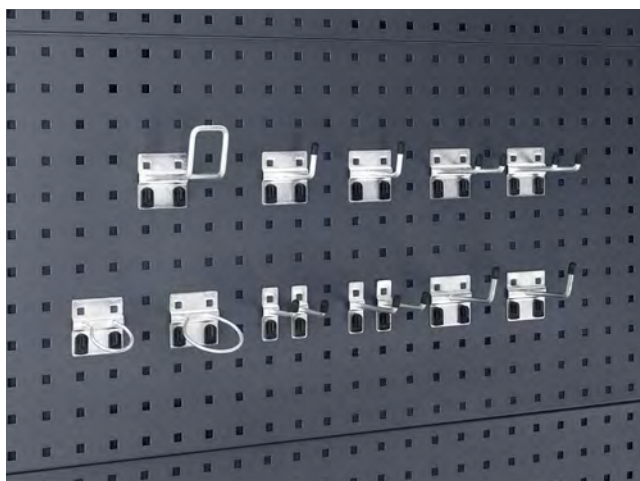

- 2 Hooks D 50 mm
- 2 Hooks D 75 mm
- 2 Extended hooks D 50 mm
- 2 Extended hooks D 75 mm
- 2 Double hooks 75 mm
- 1 Cable hook 100 mm
- 1 Power tool holder 40 mm
- 1 Power tool holder 60 mm

Weight [kg]	1.00
Order ref.	14030215

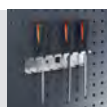

perfo hook kit 15-piece

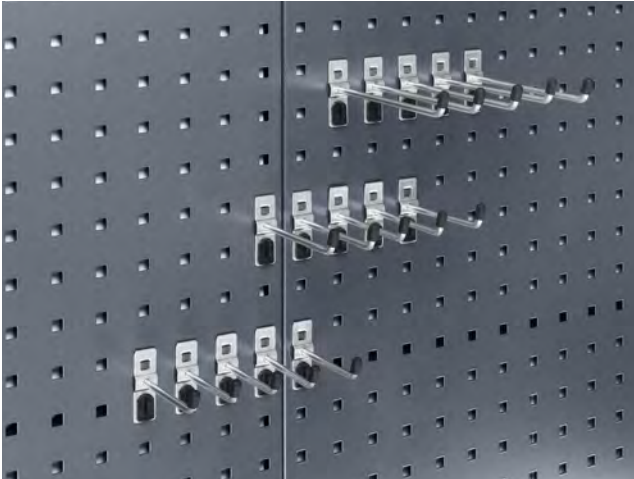

- 5 Hooks D 75 mm
- 5 Hooks D 100 mm
- 5 Hooks D 150 mm

Weight [kg]	0.13
Order ref.	14031427

perfo hook kit 20-piece



- 5 Hooks D 25 mm
- 5 Double hooks D 75 mm
- 5 Spring clips Ø 13 mm
- 1 Spanner holder
- 1 Saw holder
- 1 Screwdriver holder
- 1 Allen key holder
- 1 Drill holder

Weight [kg]	2.02
Order ref.	14031412

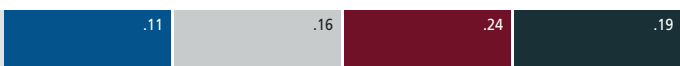

perfo panels: Details on page 15

RAL 5010 – gentian blue RAL 7035 – light grey RAL 3004 – crimson red RAL 7016 – anthracite grey

Kits

perfo hook kit 20-piece

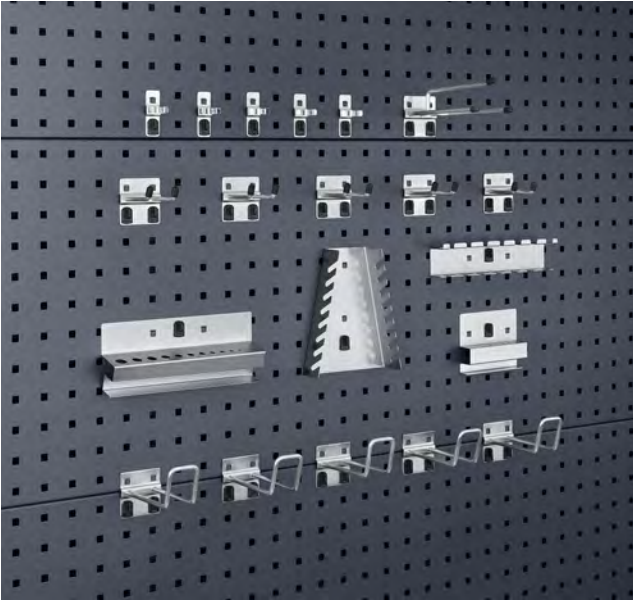

- 5 Double hooks D 50 mm
- 1 Three-pronged tool holder
- 5 Spring clips Ø 16 mm
- 1 Spanner holder
- 5 Cable hooks 100 mm
- 1 Drill holder
- 1 Screwdriver holder
- 1 Allen key holder

Weight [kg]	1.80
Order ref.	14030209

perfo hook kit 25-piece



- 5 Extended hooks D 25 mm
- 5 Extended hooks D 50 mm
- 5 Extended hooks D 75 mm
- 5 Double hooks D 50 mm
- 5 Spring clips Ø 19 mm

Weight [kg]	0.90
Order ref.	14030101

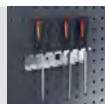

perfo hook kit 25-piece

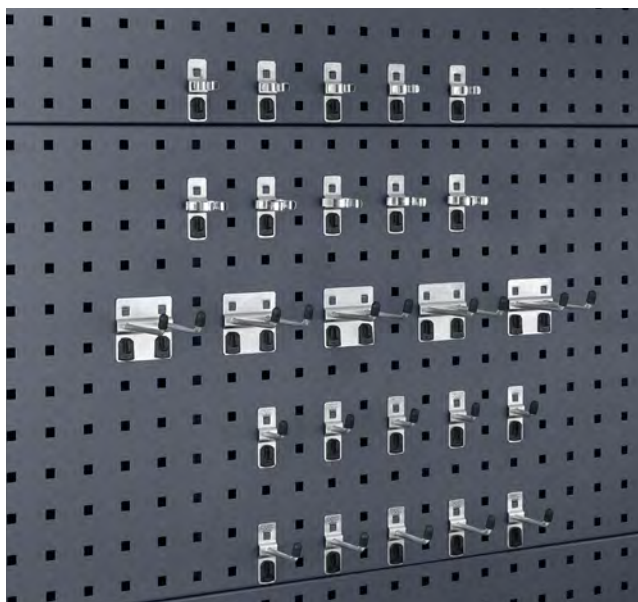

- 5 Hooks D 25 mm
- 5 Hooks D 50 mm
- 5 Double hooks D 75 mm
- 5 Spring clips Ø 16 mm
- 5 Spring clips Ø 25 mm

Weight [kg]	1.00
Order ref.	14030210

perfo hook kit 30-piece



- 5 Hooks D 25 mm
- 5 Hooks D 50 mm
- 5 Double hooks D 25 mm
- 5 Spring clips Ø 6 mm
- 5 Spring clips Ø 13 mm
- 5 Spring clips Ø 25 mm

Weight [kg]	0.80
Order ref.	14031413

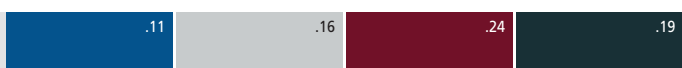

perfo panels: Details on page 15

RAL 5010 – gentian blue RAL 7035 – light grey RAL 3004 – crimson red RAL 7016 – anthracite grey

Kits

perfo hook kit 32-piece

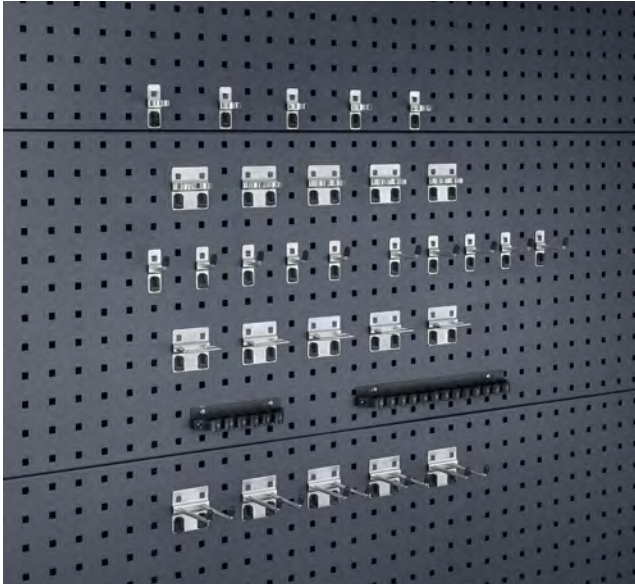

- 5 Hooks D 25 mm
- 5 Hooks D 50 mm
- 5 Double hooks D 75 mm
- 5 Double spring clip Ø 13 mm
- 5 Spring clip Ø 16 mm
- 1 Clip strip L 150 mm
- 1 Clip strip L 300 mm
- 5 U-holder 60 x 20

Weight [kg]	1.50
Order ref.	14030208

perfo hook kit 40-piece



- 5 Hooks D 25 mm
- 5 Hooks D 50 mm
- 5 Double hooks D 75 mm
- 5 Double hooks D 150 mm
- 5 U-Holder 60 x 20 mm
- 5 Spring clip Ø 13 mm
- 5 Spring clip Ø 25 mm
- 1 Spanner holder
- 1 Saw holder 1 Screwdriver holder 1 Allen key holder 1 Drill holder

Weight [kg]	1.95
Order ref.	14031414

perfo, the original

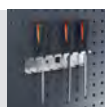

Kits

perfo hook kit 60-piece



- 5 Hooks D 25 mm
- 5 Hooks D 50 mm
- 5 Double hooks D 25 mm
- 5 Double hooks D 75 mm
- 5 Double hooks D 100 mm
- 5 Double hooks D 150 mm
- 5 U-Holder 56 x 20 mm
- 5 Spring clips Ø 6 mm
- 5 Spring clips Ø 13 mm
- 5 Spring clips Ø 19 mm
- 5 Spring clips Ø 25 mm
- 1 Spanner holder
- 1 Saw holder
- 1 Screwdriver holder
- 1 Allen key holder
- 1 Drill holder

Weight [kg]	3.49
Order ref.	14031415

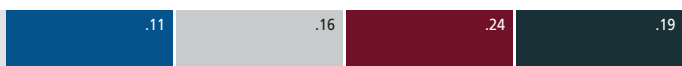
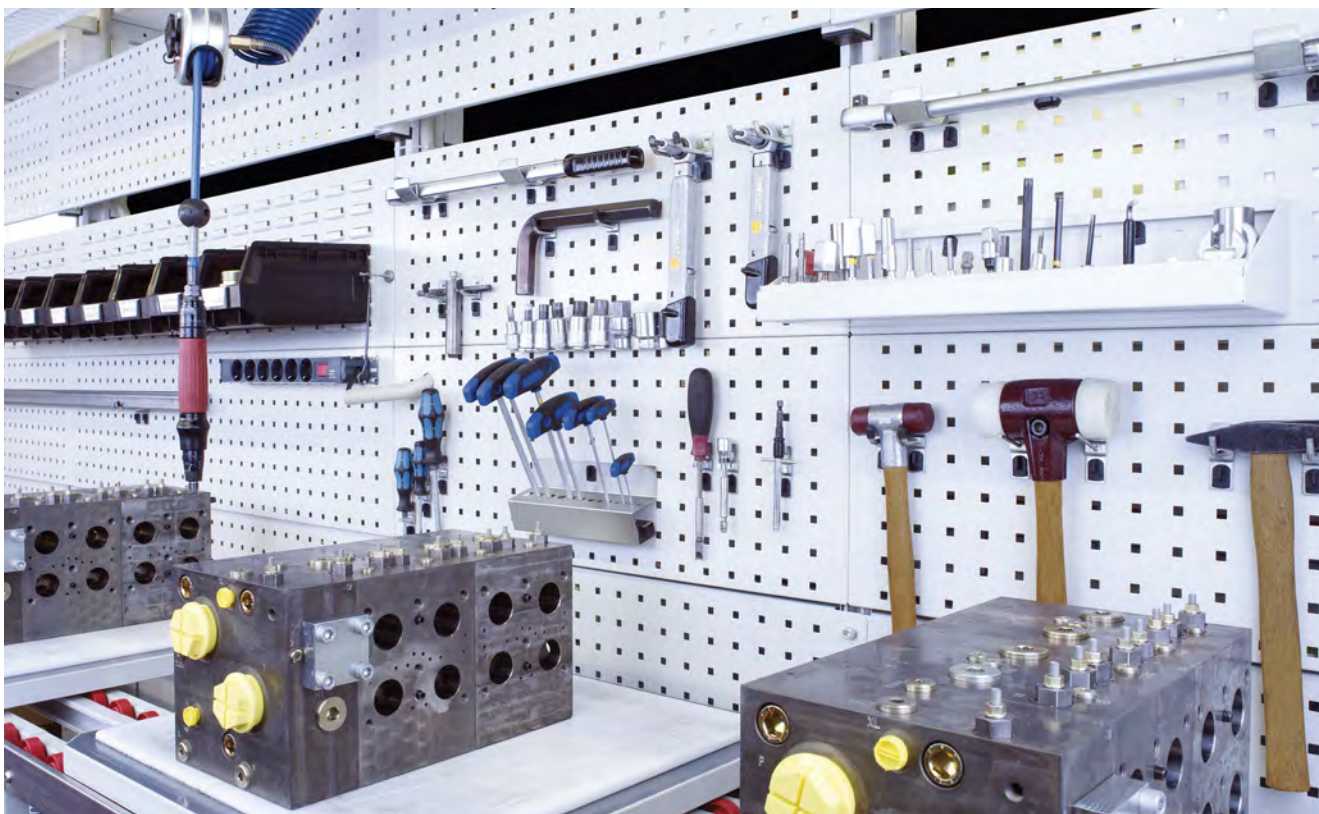

perfo panels: Details on page 15

RAL 5010 – gentian blue RAL 7035 – light grey RAL 3004 – crimson red RAL 7016 – anthracite grey

Kits

perfo hook kit 80-piece



- 5 Hooks D 25 mm
- 5 Hooks D 50 mm
- 5 Hooks D 100 mm
- 5 Double hooks D 25 mm
- 5 Double hooks D 50 mm
- 5 Double hooks D 75 mm
- 5 Double hooks D 100 mm
- 5 Double hooks D 150 mm
- 5 U-Holder 56 x 20 mm
- 5 U-Holder 32 x 75 mm
- 5 Spring clips Ø 6 mm
- 5 Spring clips Ø 10 mm
- 5 Spring clips Ø 13 mm
- 5 Spring clips Ø 19 mm
- 5 Spring clips Ø 25 mm
- 1 Spanner holder
- 1 Saw holder
- 1 Screwdriver holder
- 1 Allen key holder
- 1 Drill holder

Weight [kg]	4.57
Order ref.	14031416

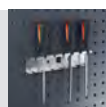

Hooks and holders for perforated panels

perfo tool pegs

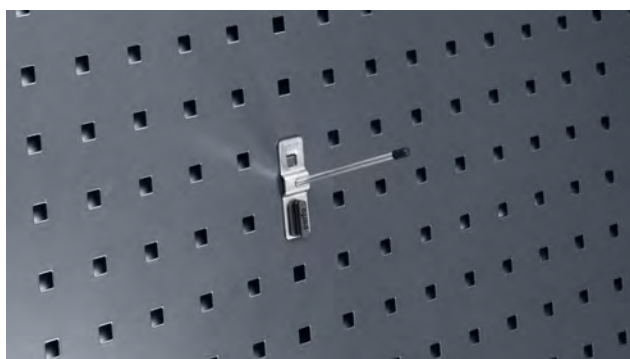

- With narrow backplate
- Angled peg



Length [mm]	25	50	75	100
Dimensions W x D x H [mm]	20 x 25 x 60	20 x 50 x 60	20 x 75 x 60	20 x 100 x 60
Ø [mm]	4	4	4	4
Weight [kg]	0.12	0.13	0.14	0.15
Pack of	5	5	5	5
Order ref.	14001110	14001164	14001165	14001108

perfo hook



- With narrow backplate
- Vertical hook end



Length [mm]	25	50	75	100	150
Dimensions W x D x H [mm]	20 x 25 x 60	20 x 50 x 60	20 x 75 x 60	20 x 100 x 60	20 x 150 x 60
Ø [mm]	6	6	6	6	6
Weight [kg]	0.15	0.18	0.21	0.24	0.30
Pack of	5	5	5	5	5
Order ref.	14001102	14001098	14001104	14001147	14001148

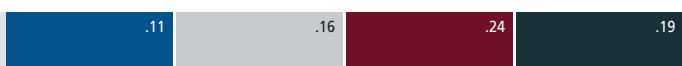

perfo panels: Details on page 15

RAL 5010 – gentian blue RAL 7035 – light grey RAL 3004 – crimson red RAL 7016 – anthracite grey

Hooks and holders for perforated panels

perfo double tool hook



- With wide backplate
- Vertical hook end / spacing 32 mm



Length [mm]	25	50	75	100	150
Dimensions W x D x H [mm]	60 x 25 x 60	60 x 50 x 60	60 x 75 x 60	60 x 100 x 60	60 x 150 x 60
Ø [mm]	6	6	6	6	6
Weight [kg]	0.35	0.41	0.47	0.52	0.64
Pack of	5	5	5	5	5
Order ref.	14002037	14002039	14002041	14002064	14002043

perfo extended hook

- With wide backplate
- Extended hook end (35 mm)

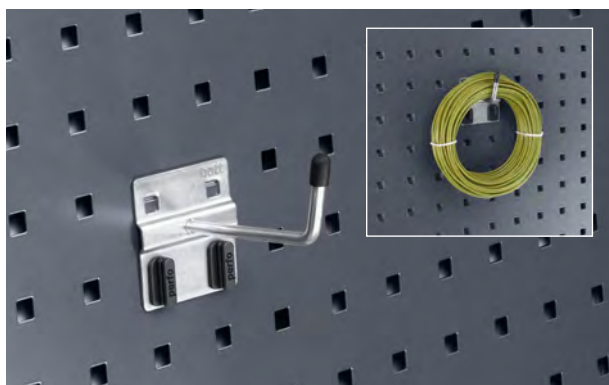

Length [mm]	25	50	75
Dimensions W x D x H [mm]	60 x 25 x 60	60 x 50 x 60	60 x 75 x 60
Ø [mm]	6	6	6
Weight [kg]	0.32	0.35	0.38
Pack of	5	5	5
Order ref.	14001117	14001119	14001121

perfo cable hook

- With wide backplate
- Vertical, closed, high hook end (50 mm)



Length [mm]	100	150	200
Dimensions W x D x H [mm]	60 x 125 x 90	60 x 175 x 90	60 x 225 x 90
Weight [kg]	0.64	0.76	0.87
Pack of	5	5	5
Order ref.	14010023	14010025	14010027

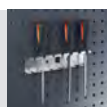

Hooks and holders for perforated panels

perfo U-holder



- With wide backplate



Length [mm]	20	20	20	50	75	100
Dimensions W x D x H [mm]	60 x 42 x 60	63 x 42 x 60	83 x 42 x 60	60 x 61 x 60	60 x 86 x 60	60 x 111 x 60
Ø [mm]	6	6	6	6	6	6
Weight [kg]	0.28	0.30	0.31	0.39	0.45	0.51
Pack of	5	5	5	5	5	5
Order ref.	14010015	14010017	14010019	14010032	14010033	14010034

perfo power tool holder

- With wide backplate



Ø [mm]	40	60	80
Weight [kg]	0.32	0.35	0.39
Pack of	5	5	5
Order ref.	14011016	14011018	14011020

perfo clip strip

- With resilient plastic sprung loops
- Width 150 mm with 5 clip positions, Width 300 mm with 13 clip positions
- For holding tools and other parts
- Material: Base carrier: Anodised aluminium, Clips: Plastic
- Fixings included
- Colour: black

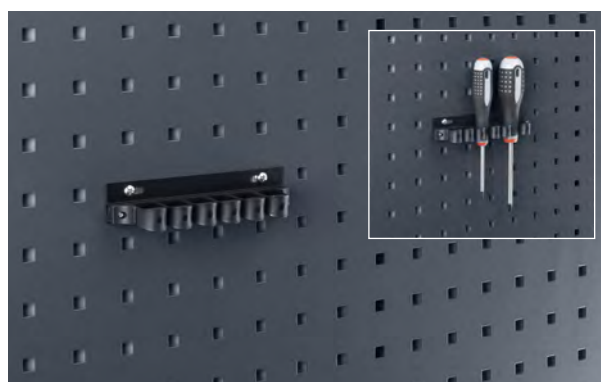

Dimensions W x D x H [mm]	150 x 37 x 29	300 x 37 x 28
Weight [kg]	0.18	0.27
Pack of	3	3
Order ref.	13008008	13008009

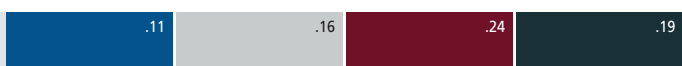

perfo panels: Details on page 15

RAL 5010 – gentian blue RAL 7035 – light grey RAL 3004 – crimson red RAL 7016 – anthracite grey

Hooks and holders for perforated panels

perfo spring clip



■ rotatable clip

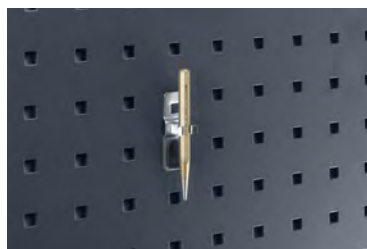

Dimensions W x D x H [mm]	20 x 20 x 60	24 x 28 x 60	28 x 32 x 60	28 x 32 x 60	30 x 46 x 60
Ø [mm]	6	10	13	16	19
Weight [kg]	0.11	0.11	0.12	0.12	0.13
Pack of	5	5	5	5	5
Order ref.	14013059	14013061	14013063	14013065	14013067
Dimensions W x D x H [mm]	39 x 50 x 60	20 x 62 x 60	20 x 63 x 60	60 x 64 x 60	60 x 73 x 60
Ø [mm]	25	28	32	38	51
Weight [kg]	0.13	0.15	0.17	0.34	0.36
Pack of	5	5	5	5	5
Order ref.	14013069	14013071	14013073	14013055	14013057

perfo three-pronged holder



■ With wide backplate



Length [mm]	150
Ø [mm]	6
Weight [kg]	0.17
Pack of	1
Order ref.	14006003

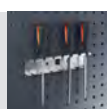

Hooks and holders for perforated panels

perfo double spring clip



- With wide backplate; rotatable clip



Dimensions W x D x H [mm]	60 x 20 x 60	60 x 28 x 60	60 x 32 x 60	60 x 32 x 60	60 x 46 x 60
Ø [mm]	6	10	13	16	19
Weight [kg]	0.27	0.27	0.28	0.29	0.30
Pack of	5	5	5	5	5
Order ref.	14013075	14013077	14013079	14013081	14013083

perfo power tool holder



- Power tool holder/cartridge holder/can holder made of flexible silicone with powerful neodymium magnet
- Makes screwless and flexible fixing on magnetic surfaces possible
- Diameter: 70 mm



Dimensions W x D x H [mm]	70 x 75 x 28
Order ref.	14021059.10V

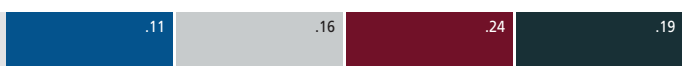

perfo panels: Details on page 15

RAL 5010 – gentian blue RAL 7035 – light grey RAL 3004 – crimson red RAL 7016 – anthracite grey

Hooks and holders for perforated panels

perfo combined holder

- With wide backplate; 2-piece or individual parts; 3 compartments

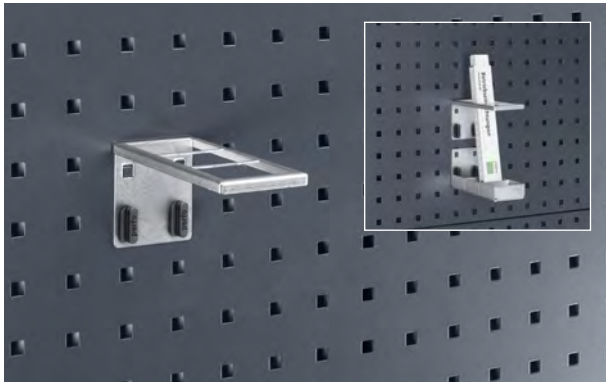

Version	top part	bottom part	complete
Dimensions W x D [mm]	60 x 153	60 x 153	60 x 153
Compartment W x D [mm]	44 x 47	49 x 57	44 x 47
Weight [kg]	0.09	0.32	0.42
Pack of	1	1	1
Order ref.	14022009	14022010	14022011

perfo magnet holder

- With strong neodymium magnet
- Slip-resistant rubber surface

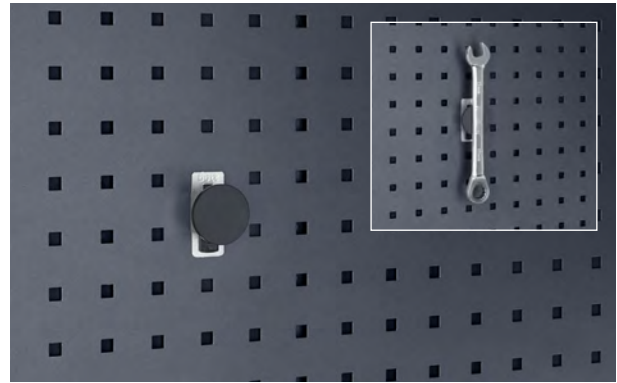

Ø [mm]	40
Weight [kg]	0.06
Pack of	2
Order ref.	14022035

perfo magnetic holder

- for suspending drawings, documents etc.

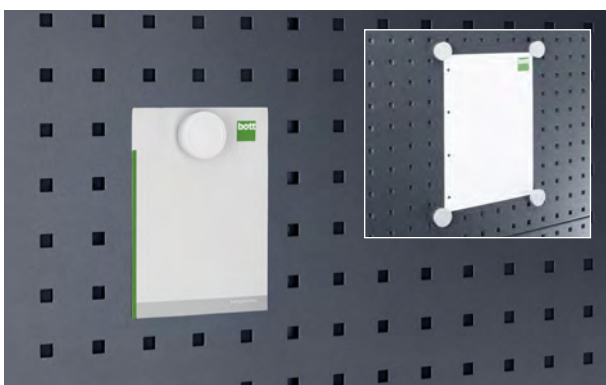

Ø [mm]	35
Weight [kg]	0.18
Pack of	5
Order ref.	80501002

perfo spigot for perforated panels

- Tube Ø 16 mm
- Colour: light grey (RAL 7035)

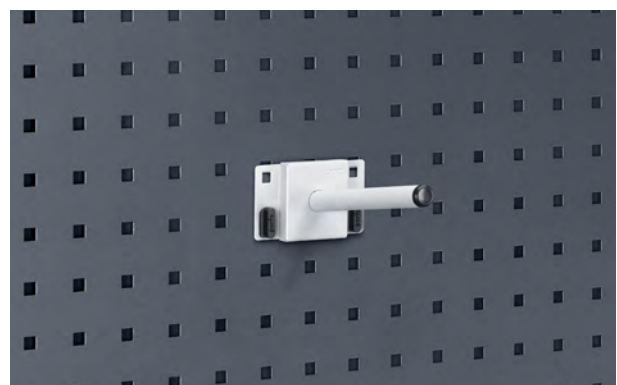

Dimensions W x D x H [mm]	95 x 170 x 60	95 x 220 x 60	95 x 320 x 60
Ø [mm]	16	16	16
Weight [kg]	0.16	0.18	0.22
Pack of	1	1	1
Order ref.	14022049.16	14022050.16	14022051.16

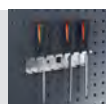
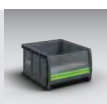

Hooks and holders for perforated panels

perfo pipe bracket



- Sturdy holder for storing large and round tools



Dimensions W x D x H [mm]	60 x 66 x 60	60 x 106 x 60	100 x 104 x 90	100 x 104 x 90
Ø [mm]	60	100	60	100
Weight [kg]	0.19	0.28	0.50	0.65
Pack of	2	2	2	2
Order ref.	14015041	14015042	14015043	14015044

perfo velcro holder

- Secure and easy fixing of wires, cables or hoses
- Can be rotated 360°, giving it many possible applications

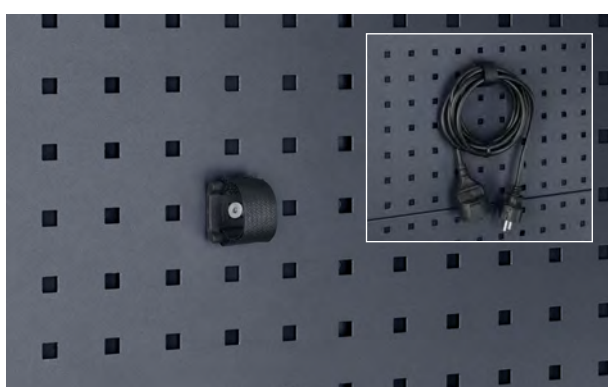

Dimensions W x D x H [mm]	34 x 37 x 12
Weight [kg]	0.57
Pack of	5
Order ref.	14013103.90

perfo seven prong holder

- With wide backplate; 7 holders 80 mm / distance 44 mm



Dimensions W x D x H [mm]	170 x 150 x 60
Ø [mm]	6
Weight [kg]	0.21
Pack of	1
Order ref.	14006002

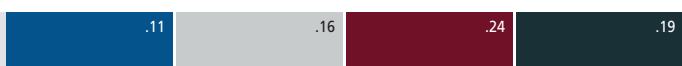

perfo panels: Details on page 15

RAL 5010 – gentian blue RAL 7035 – light grey RAL 3004 – crimson red RAL 7016 – anthracite grey

Hooks and holders for perforated panels

perfo spanner holder

- For the clear and ergonomic storage of open-ended and ring spanners

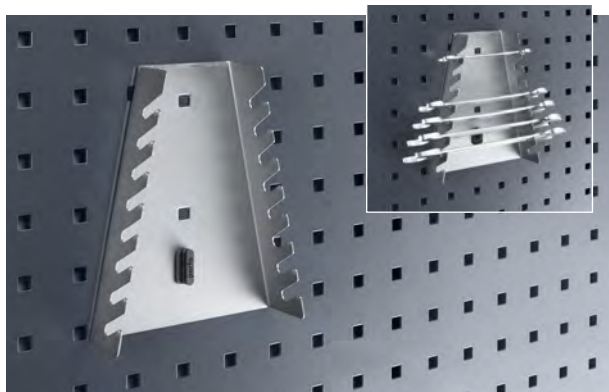

Dimensions W x D x H [mm]	145 x 40 x 180
Weight [kg]	0.31
Pack of	1
Order ref.	14017002

perfo screwdriver holder

- perfo screwdriver holder
- 4 positions Ø 7mm
- 3 positions Ø 13mm

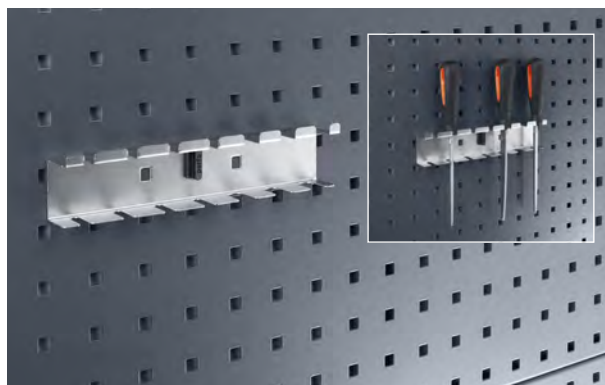

Dimensions W x D x H [mm]	225 x 30 x 50
Weight [kg]	0.19
Pack of	1
Order ref.	14019007

perfo saw holder

- For the safe storage of frame saws

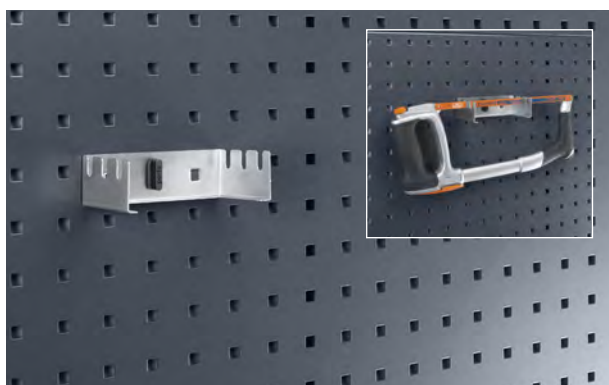

Dimensions W x D x H [mm]	125 x 70 x 38
Weight [kg]	0.09
Pack of	1
Order ref.	14019003

perfo flexible spring clip

- The cam-buckle adapts flexibly to different handle diameters

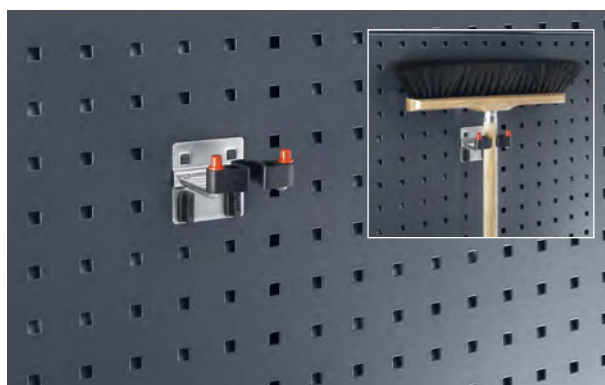

Dimensions W x D x H [mm]	78 x 86 x 64	85 x 92 x 69
Ø [mm]	15-25	25-40
Weight [kg]	0.09	0.11
Pack of	1	1
Order ref.	12626025	12626026

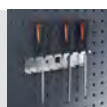

Hooks and holders for perforated panels

perfo socket holder

- For 1/2" sockets

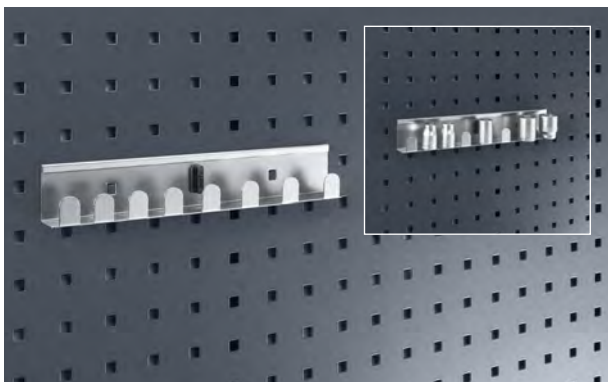

Colour	Silver
Dimensions W x D x H [mm]	270 x 27 x 45
Weight [kg]	0.16
Pack of	1
Order ref.	14018004

perfo tool block

- Plastic block for self-drilling



Dimensions W x D x H [mm]	115 x 75 x 90	450 x 75 x 90
Weight [kg]	0.33	1.30
Pack of	1	1
Order ref.	14021017	14021040

perfo drill holder / Allen key holder

- For the clear and ergonomic storage of drills and allen key



Dimensions W x D x H [mm]	115 x 25 x 90	225 x 50 x 85
Ø [mm]	2-12	2-15
Weight [kg]	0.12	0.33
Pack of	1	1
Order ref.	14020002	14020036

perfo support rail for bottBoxes

- Colour: light grey (RAL 7035)



Dimensions W x D x H [mm]	100 x 18 x 78	450 x 18 x 78	900 x 18 x 78
Weight [kg]	0.13	0.61	1.39
Pack of	1	1	1
Order ref.	14014043.16	14014044.16	14014045.16

.11

.16

.24

.19

Hooks and holders for perforated panels

perfo storage shelf



■ Colour: light grey (RAL 7035)

Dimensions W x D x H [mm]	450 x 170 x 105	900 x 170 x 105	450 x 250 x 105	900 x 250 x 105
Weight [kg]	1.50	2.53	1.89	3.16
Pack of	1	1	1	1
Order ref.	14014034.16	14014006.16	14014031.16	14014007.16

perfo storage box

■ Colour: light grey (RAL 7035)



Dimensions W x D x H [mm]	225 x 175 x 65	440 x 175 x 65
Weight [kg]	0.77	1.30
Pack of	1	1
Order ref.	14014037.16	14014038.16

perfo storage shelf S

■ Colour: light grey (RAL 7035)



Dimensions W x D x H [mm]	154 x 89 x 39	154 x 164 x 39
Weight [kg]	0.35	0.40
Pack of	1	1
Order ref.	14008066.16	14008065.16

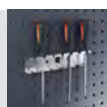

Hooks and holders for perforated panels

perfo lashing strap with plastic hooks

- With cam buckle
- Colour: anthracite grey (RAL 7016)



Dimensions W x D x H [mm]	2500 x 0 x 25
Weight [kg]	0.18
Pack of	1
Order ref.	62626043.19V

perfo adjustable bungee strap set

- Can be cut to required length, for attaching parts to perforated panel

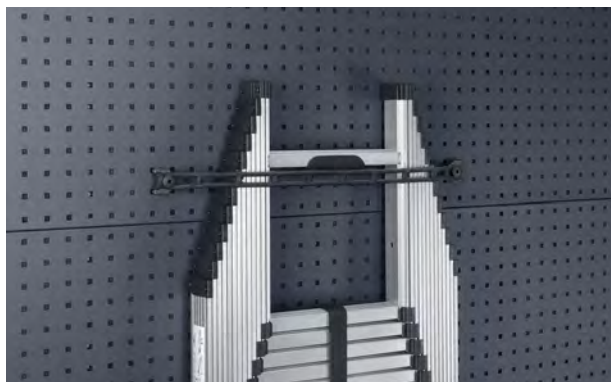

Dimensions W x D x H [mm]	2000 x 10 x 30
Weight [kg]	0.40
Pack of	1
Order ref.	63003045.90V

perfo catalogue holder DIN A3

- Colour: light grey (RAL 7035)



Dimensions W x D x H [mm]	450 x 250 x 285
Weight [kg]	2.73
Pack of	1
Order ref.	14014008.16

perfo document holder DIN A4

- Colour: light grey (RAL 7035)



Dimensions W x D x H [mm]	224 x 20 x 302
Weight [kg]	0.70
Pack of	1
Order ref.	14014009.16

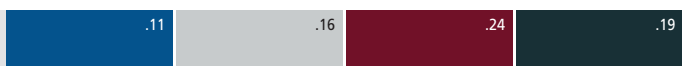

perfo panels: Details on page 15

RAL 5010 – gentian blue RAL 7035 – light grey RAL 3004 – crimson red RAL 7016 – anthracite grey

Hooks and holders for perforated panels

perfo document pocket



- With transparent cover, for DIN A4 and A3 formats

DIN Format	A4 portrait	A4 landscape	A3 portrait	A3 landscape
Dimensions W x D x H [mm]	215 x 4 x 300	300 x 4 x 215	300 x 4 x 423	423 x 4 x 300
Weight [kg]	0.58	0.58	1.10	1.10
Pack of	1	1	1	1
Order ref.	14014024.16	14014025.16	14014026.16	14014027.16

perfo presentation rails

- for suspending drawings, documents etc.

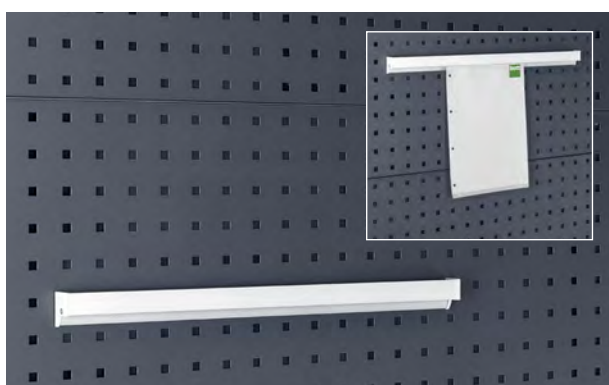

Dimensions W x D x H [mm]	500 x 10 x 50	1000 x 10 x 50
Weight [kg]	0.18	0.36
Pack of	1	1
Order ref.	14022042	14022043

perfo wire basket

- Stable wire basket for storing larger materials
- Load capacity: 15 kg



Dimensions W x D x H [mm]	473 x 303 x 220	473 x 403 x 220
Weight [kg]	2.00	2.40
Pack of	1	1
Order ref.	02508001	02508002

perfo, the original



310 Compatible bottBoxes from page 226

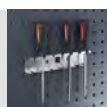

perfo hooks and holders from page 299

Hooks and holders for perforated panels

TiltBox



- Practical small parts tilt bin for simple installation on bott vario end frames and perfo perforated panels
- Includes 1 divider
- The transparent insert can be removed
- Simple and secure operation thanks to central pushbutton
- An additional divider can be used to divide the TiltBox into three sections of approximately equal size
- Load capacity: 15 kg



Version	Tiltbox	Tiltbox	Additional TiltBox divider
Dimensions W x D x H [mm]	304 x 147 x 196	304 x 147 x 196	3 x 106 x 171
Weight [kg]	0.88	7.04	0.05
Pack quantity	1	8	1
Order ref.	14014060.19V	14014063.19V	14014065
Final installation [WU]	1.0	8.0	0.0

perfo transparent tilt bin



- For the clear storage of small parts
- The transparent inserts can be removed individually
- incl. holder for mounting to perfo panels
- Material: Plastic
- Colour: anthracite grey / transparent

Version	With fixing brackets (pair)	With pair of fixing brackets	With pair of fixing brackets
Dimensions W x D x H [mm]	600 x 68 x 78	600 x 96 x 112	600 x 142 x 168
Weight [kg]	0.80	1.20	2.00
Pack of	1	1	1
Order ref.	02513016.19	02513017.19	02513018.19

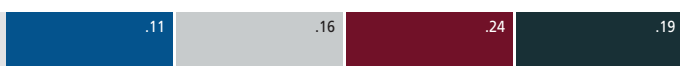

perfo panels: Details on page 15

RAL 5010 – gentian blue RAL 7035 – light grey RAL 3004 – crimson red RAL 7016 – anthracite grey

Hooks and holders for perforated panels

perfo document holder

- Easy clip-on plastic holder for DIN A4 landscape format
- Incl. colour coded label strip and fixing kit

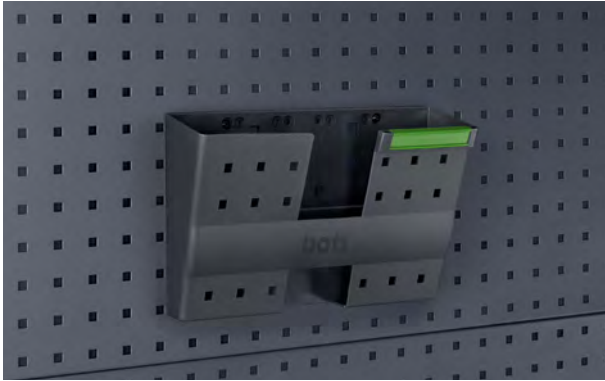

DIN Format	A4 landscape
Dimensions W x D x H [mm]	340 x 100 x 213
Weight [kg]	1.90
Pack of	5
Order ref.	14014029.19

perfo rubbish bag holder 1 - 16 litres

- Made of anodised aluminium
- Including 1 roll of rubbish bags 5 l (50 pieces)



Version	Waste container	1 roll of rubbish bags (50 pieces)
Dimensions W x D x H [mm]	187 x 103 x 275	450 x 450 x 520
Weight [kg]	0.45	0.20
Pack of	1	2
Order ref.	63003105.97	63003106

perfo rubbish bag holder 60 - 120 litres

- For conventional 60 - 120 l rubbish bag containers
- Colour: light grey (RAL 7035)



Dimensions W x D x H [mm]	350 x 340 x 175
Weight [kg]	1.90
Pack of	1
Order ref.	14022036.16V

perfo rubbish bag holder 60 - 120 litres

- For conventional 60 - 120 l rubbish bag containers
- Colour: light grey (RAL 7035)



Dimensions W x D x H [mm]	350 x 340 x 175
Weight [kg]	2.60
Pack of	1
Order ref.	14022058.16

perfo, the original



312 Compatible bottBoxes from page 226

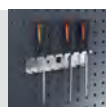

perfo hooks and holders from page 299

Hooks and holders for perforated panels

perfo rubbish bag holder - support shelf

- For supporting heavy rubbish sacks, carrying capacity 10 kg
- Colour: light grey (RAL 7035)



Dimensions W x D x H [mm]	310 x 310 x 150
Weight [kg]	1.46
Pack of	1
Order ref.	14022037.16V

perfo paper roll holder

- For paper rolls max. 380 mm wide, Ø up to 390 mm incl. 1 paper roll
- Free-running, with brake function, light grey (RAL 7035) or anthracite grey (RAL 7016)



Version	Paper roll holder (RAL 7035)	Paper rolls
Dimensions W x D x H [mm]	424 x 231 x 226	200 x 130 x 130
Max. roll width [mm]	380 mm	
Weight [kg]	2.80	7.14
Pack of	1	12
Order ref.	14022045.16	63003074.90V

perfo paper roll holder with tear-off edge

- For paper rolls with a max. width of 220 mm
- Serrated tear-off edge for paper without perforation



Dimensions W x D x H [mm]	360 x 145 x 190	775 x 145 x 190
Max. roll width [mm]	300 mm	700 mm
Weight [kg]	1.18	1.62
Pack of	1	1
Order ref.	14022038.16V	14022039.16V

perfo paper roll holder, self-securing

- For paper rolls with a max. width of 260 mm, Ø 280 mm
- Includes 1 paper roll



Version	Paper roll holder	Paper rolls
Dimensions W x D x H [mm]	315 x 185 x 180	200 x 130 x 130
Max. roll width [mm]	260 mm	
Weight [kg]	1.82	7.14
Pack of	1	12
Order ref.	63003058.19V	63003074.90V

.11

.16

.24

.19

Hooks and holders for perforated panels

perfo sandpaper roll holder

- Max. roll diameter = 260 mm
- Shaft diameter 15 mm

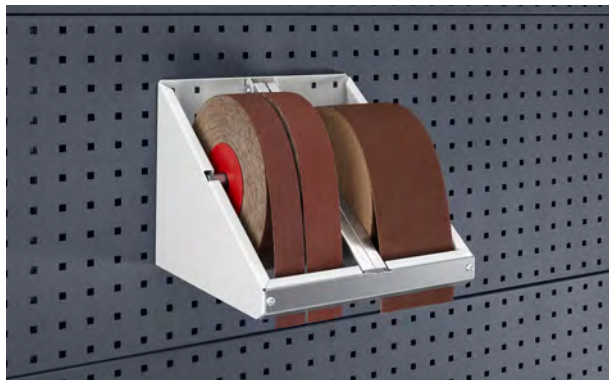

Dimensions W x D x H [mm]	315 x 295 x 250
Max. roll width [mm]	120 mm
Weight [kg]	2.98
Pack of	1
Order ref.	14022040.16V

perfo adhesive tape dispenser

- For adhesive and parcel tapes up to a max. width of 50 mm
- With hardened and ground blade



version	perfo dispenser	Spare blades
Dimensions W x D x H [mm]	82 x 181 x 140	54 x 1 x 25
Weight [kg]	0.50	0.03
Pack of	1	5
Order ref.	14022052.19	14022053

perfo cable holder

- Includes strap

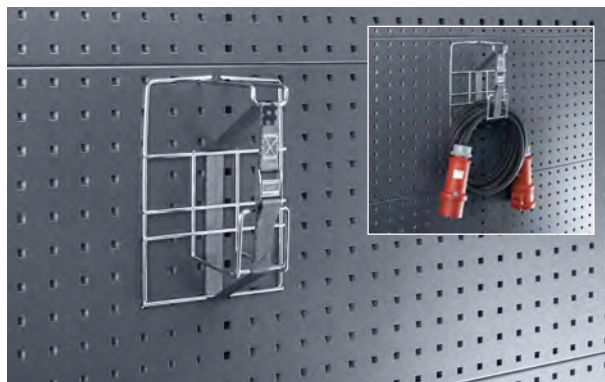

Dimensions W x D x H [mm]	195 x 130 x 300
Weight [kg]	0.50
Pack of	1
Order ref.	14022003

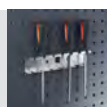

Hooks and holders for perforated panels

perfo hose holder



- For storage of hoses and cables
- Made of die-cast aluminium



Dimensions W x D x H [mm]	190 x 70 x 145	265 x 105 x 200	350 x 145 x 255	415 x 190 x 305
Weight [kg]	0.29	0.48	1.14	2.38
Pack of	1	1	1	1
Order ref.	14050001	14050002	14050003	14050004

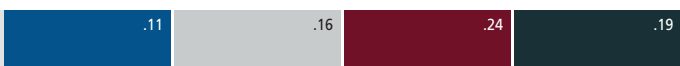
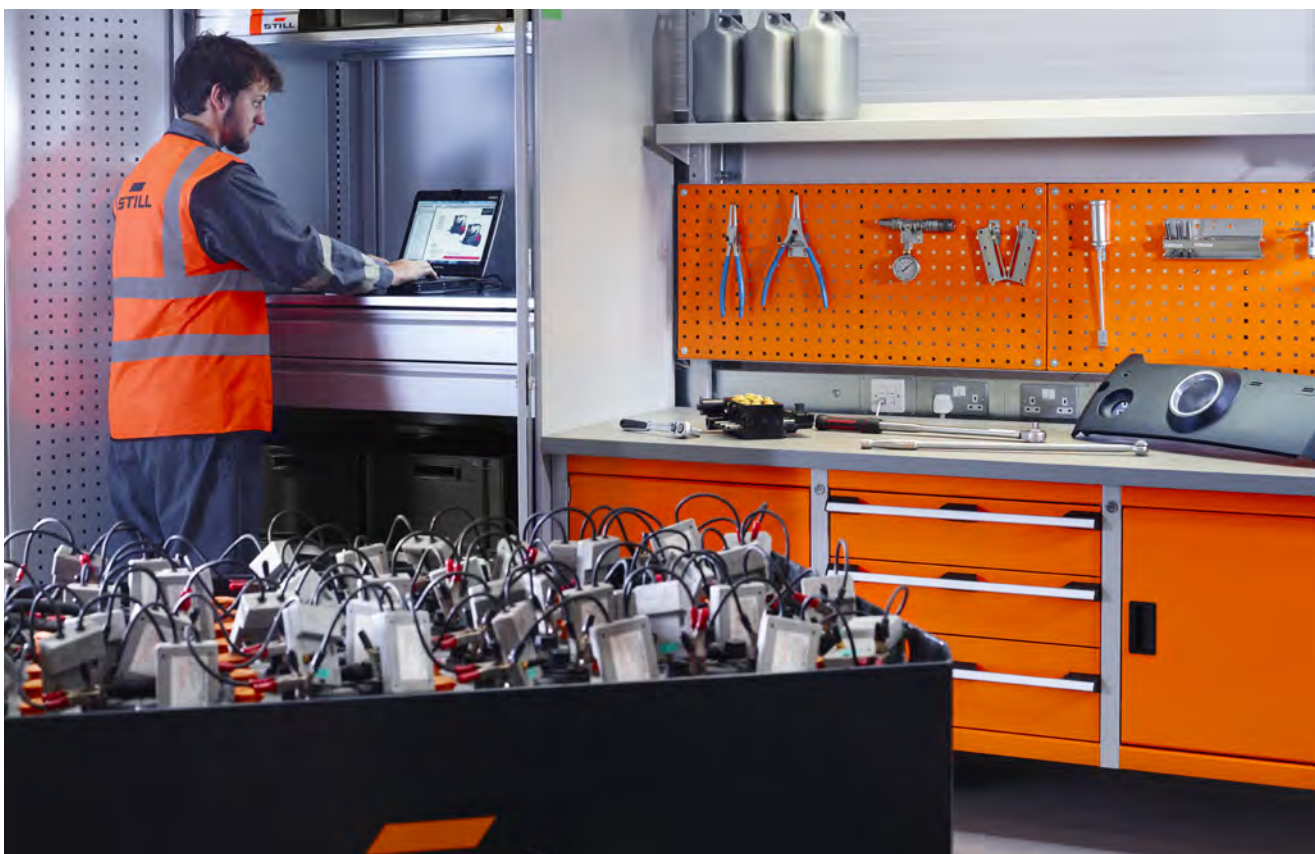

perfo panels: Details on page 15

RAL 5010 – gentian blue RAL 7035 – light grey RAL 3004 – crimson red RAL 7016 – anthracite grey

Hooks and holders for perforated panels

perfo can and cartridge holder, angled

- For cartridges up to max. Ø 50 mm



Colour	Light grey	Anthracite grey
Dimensions W x D x H [mm]	225 x 100 x 165	225 x 100 x 165
Weight [kg]	0.58	0.42
Pack of	1	1
Order ref.	14021054.16V	14021054.19V

perfo can and cartridge holder, angled

- For cans up to max. Ø 68 mm



Colour	Light grey	Anthracite grey
Dimensions W x D x H [mm]	225 x 100 x 165	225 x 100 x 165
Weight [kg]	0.58	0.39
Pack of	1	1
Order ref.	14021055.16V	14021055.19V

perfo can and cartridge holder

- Powder-coated steel, anthracite grey RAL 7016
- With 2 locations, max. Ø 70 mm

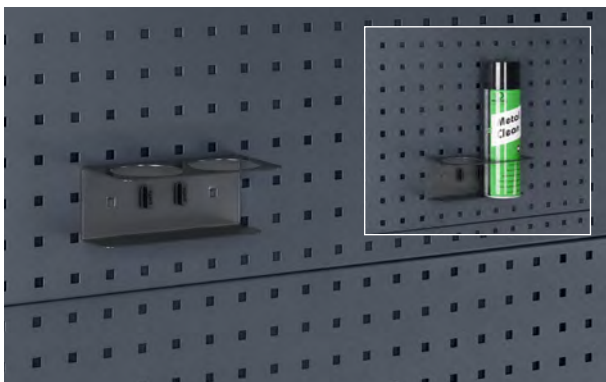

Colour	Anthracite grey
Dimensions W x D x H [mm]	175 x 87 x 70
Weight [kg]	0.39
Pack of	1
Order ref.	14021053.19V

perfo can and cartridge holder

- With 2 locations, max. Ø 80 mm
- Material: Plastic

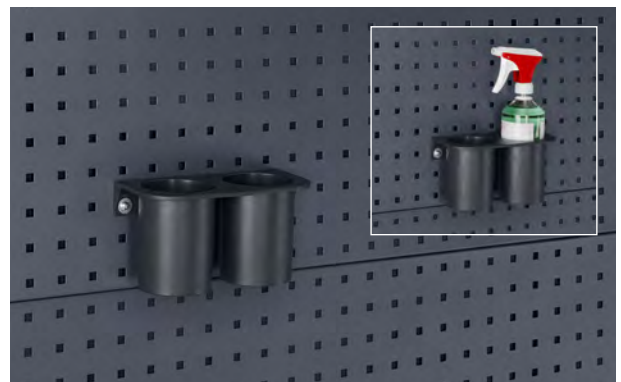

Colour	Black
Dimensions W x D x H [mm]	215 x 110 x 115
Weight [kg]	0.20
Pack of	1
Order ref.	14021056.10V

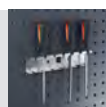

Hooks and holders for perforated panels

perfo adapter for louvred panels

- Allows all perfo accessories to be used on perfo louvred panels
- light grey (RAL 7035)

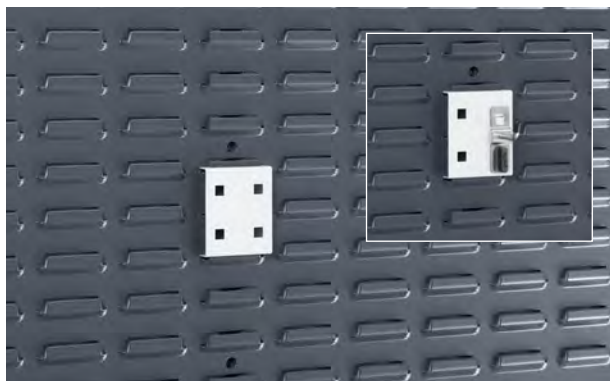

Dimensions W x D x H [mm]	65 x 15 x 77
Weight [kg]	0.05
Pack of	1
Order ref.	14005025.16

perfo spigot for louvred panels

- Tube Ø 16 mm
- Colour: light grey (RAL 7035)



Length [mm]	200	150	300
Dimensions W x D x H [mm]	68 x 229 x 77	68 x 170 x 77	68 x 320 x 77
Ø [mm]	16	16	16
Weight [kg]	0.19	0.16	0.24
Pack of	1	1	1
Order ref.	14022022.16	14022024.16	14022025.16

perfo soap dispenser

- Made of plastic, includes 1 litre liquid soap



Version	perfo soap dispenser	1 L liquid soap
Dimensions W x D x H [mm]	100 x 130 x 290	400 x 300 x 120
Weight [kg]	1.50	6.50
Pack of	1	6
Order ref.	02509004	89905002

perfo hand towel dispenser

- Made of plastic, includes 1 paper roll



Version	perfo hand towel dispenser	Paper rolls
Dimensions W x D x H [mm]	185 x 170 x 340	200 x 130 x 130
Weight [kg]	1.54	7.40
Pack of	1	12
Order ref.	02509003	89905001

.11

.16

.24

.19

Hygiene

perfo water dispenser set

- 12 litre holding capacity
- Dispensing tap on container base
- With aluminium shelf and fixing strap
- Dispenser bottle with pump dispenser for on-site filling with cleaning agent or disinfectant



Dimensions W x D x H [mm]	370 x 173 x 375
Weight [kg]	1.46
Pack of	1
Order ref.	63003059.19V

perfo holder for disposable gloves

- For the simple provision of single-use gloves



Dimensions W x D x H [mm]	260 x 175 x 85
Weight [kg]	0.63
Pack of	1
Order ref.	14022055.16

Hand wash unit 12V

- Max. water temperature 60°C
- With overheat protection
- Incl. cable set, container with securing strap and fixing material



Dimensions W x D x H [mm]	300 x 230 x 525
Weight [kg]	7.00
Pack of	1
Order ref.	50202002

Dispenser bottle with perfo holder

- Dispenser bottle with pump dispenser for on-site filling with cleaning agent or disinfectant
- Holder ø 72 mm, with secure perfo lock clip



Execution	perfo dispenser bottle with holder
Dimensions W x D x H [mm]	92 x 87 x 190
Weight [kg]	0.18
Pack of	1
Order ref.	14011010.19V

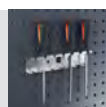

Scrubs tub



- In a handy dispenser

Version	Holder with 30-towel tub	Individual holder for 30-towel tub	30-towel tub	30-towel tub	Holder with 72-towel tub	Individual holder for 72-towel tub	72-towel tub	72-towel tub
Weight [kg]	0.50	0.26	0.24	1.44	1.32	0.32	1.00	6.00
Pack of	1	1	1	6	1	1	1	6
Order ref.	89905005	14022006	89905003	89905004	89905008	14022008	89905007	89905009

Scrubs single towels



- Highly effective cleaning solution for tough greases, lubricants, adhesives, oil, tar, asphalt, ink, wax, carbon, grass stains, resin etc. Scrubs cleaning towels have an antibacterial effect, are free of toxins, non-poisonous, non-irritant, have skin-care substances which act against drying skin and do not burn on injured skin.

Version	Individual towels	Individual towels
Weight [kg]	0.55	2.20
Pack of	50	200
Order ref.	89905026	89905014

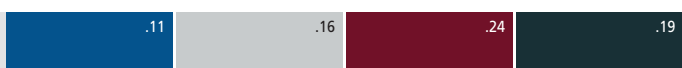

Racks

with perfo louvred panels and bottBoxes

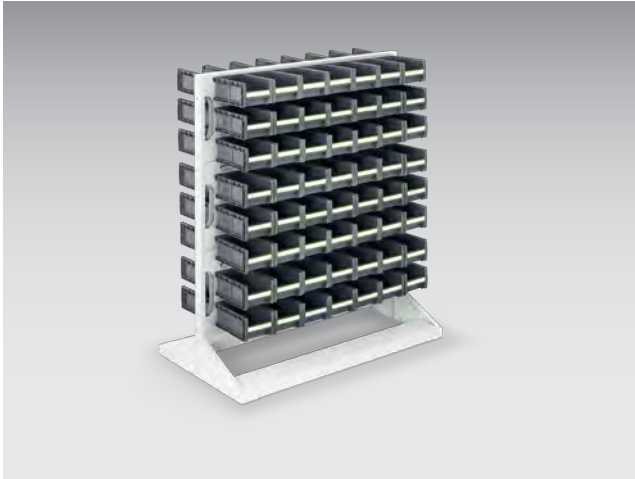

- 112 Piece kit
- 112 bottBox M2 (130 x 198 x 90 mm)

Version	With bottBoxes	Empty
Number of bottBoxes	112 x M2	
Dimensions W x D x H [mm]	1000 x 550 x 1125	1000 x 550 x 1125
Weight [kg]	48.00	27.96
Order ref.	16917350.16V	16917120.16V

with perfo louvred panels and bottBoxes



- 112 Piece kit
- 42 bottBox M2 (130 x 298 x 90 mm)
- 70 bottBox M3 (130 x 298 x 165 mm)

Version	With bottBoxes	Empty
Number of bottBoxes	42 x M2; 70 x M3	
Dimensions W x D x H [mm]	1000 x 550 x 1450	1000 x 550 x 1450
Weight [kg]	66.00	34.52
Order ref.	16917360.16V	16917121.16V

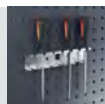

with perfo louvred panels and bottBoxes



- Kit 140-piece
- 70 bottBox M2 (130 x 298 x 90 mm)
- 70 bottBox M3 (130 x 298 x 165 mm)

Version	with bottBoxes	empty
Number of bottBoxes	70 x M2; 70 x M3	
Dimensions W x D x H [mm]	1000 x 550 x 1775	1000 x 550 x 1775
Weight [kg]	77.50	41.06
Order ref.	16917370.16V	16917122.16V

mobile with perfo louvred panels and bottBoxes



- 84 Piece kit
- 42 bottBox M2 (130 x 198 x 90 mm)
- 42 bottBox M3 (130 x 298 x 165 mm)
- 4 Swivel & brake castors

Version	With bottBoxes	Empty
Number of bottBoxes	42 x M2; 42 x M3	
Dimensions W x D x H [mm]	1000 x 550 x 1250	1000 x 550 x 1250
Weight [kg]	53.00	28.64
Order ref.	16917390.16V	16917170.16V

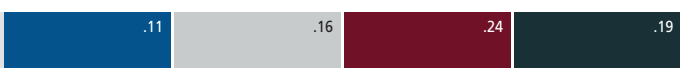

perfo panels: Details on page 15

RAL 5010 – gentian blue RAL 7035 – light grey RAL 3004 – crimson red RAL 7016 – anthracite grey

Racks

with perfo perforated panels and hook kit



- Kit 80-piece
- 10 perfo perforated panels 5 Spring clips Ø 6 mm
- 5 Hooks D 25 mm
- 5 Hooks D 50 mm
- 5 Hooks D 100 mm
- 5 Double hooks D 25 mm
- 5 Double hooks D 50 mm
- 5 Double hooks D 75 mm
- 5 Double hooks D 100 mm
- 5 Double hooks D 150 mm
- 5 U-Holder 60 x 20 mm
- 5 U-Holder 40 x 75 mm
- 5 Spring clips Ø 6 mm
- 5 Spring clips Ø 10 mm
- 5 Spring clips Ø 13 mm
- 5 Spring clips Ø 19 mm
- 5 Spring clips Ø 25 mm
- 1 Spanner holder
- 1 Saw holder
- 1 Screwdriver holder
- 1 Allen key holder
- 1 Drill holder

Version	With 80 piece hook kit	empty
Dimensions W x D x H [mm]	1000 x 550 x 1775	1000 x 550 x 1775
Weight [kg]	43.50	35.50
Order ref.	16917202.**V	16917102.**V

perfo, the original

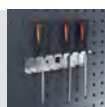

Racks

with perfo perforated panels and hook kit

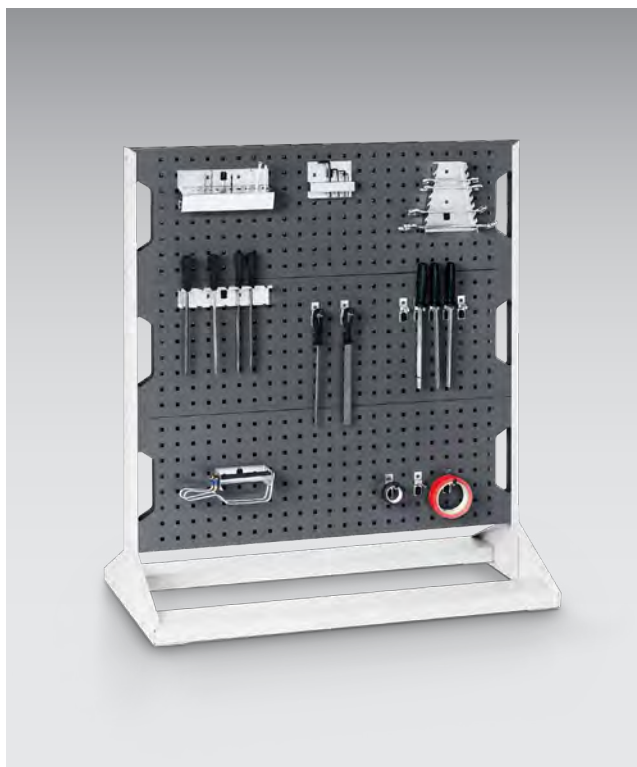

- 40 Piece kit
- 10 Hooks
- 10 Double hooks
- 5 U-holder
- 10 Spring clips
- 1 Spanner holder
- 1 Saw holder
- 1 Screwdriver holder
- 1 Allen key holder
- 1 Drill holder

Version	With 40 piece hook kit	Empty
Dimensions W x D x H [mm]	1000 x 550 x 1125	1000 x 550 x 1125
Weight [kg]	27.30	24.50
Order ref.	16917200.**V	16917100.**V

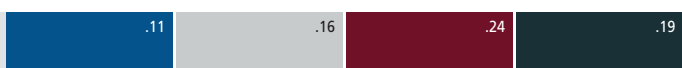

perfo panels: Details on page 15

RAL 5010 – gentian blue RAL 7035 – light grey RAL 3004 – crimson red RAL 7016 – anthracite grey

Racks

with perfo perforated panels and hook kit



- 60 Piece kit
- 10 Hooks
- 20 Double tool hooks
- 5 U-holders
- 20 Spring clips
- 1 Spanner holder
- 1 Saw holder
- 1 Screwdriver holder
- 1 Allen key holder
- 1 Drill holder

Version	With 60-piece hook kit	Empty
Dimensions W x D x H [mm]	1000 x 550 x 1450	1000 x 550 x 1450
Weight [kg]	33.80	30.00
Order ref.	16917201.**V	16917101.**V

perfo, the original

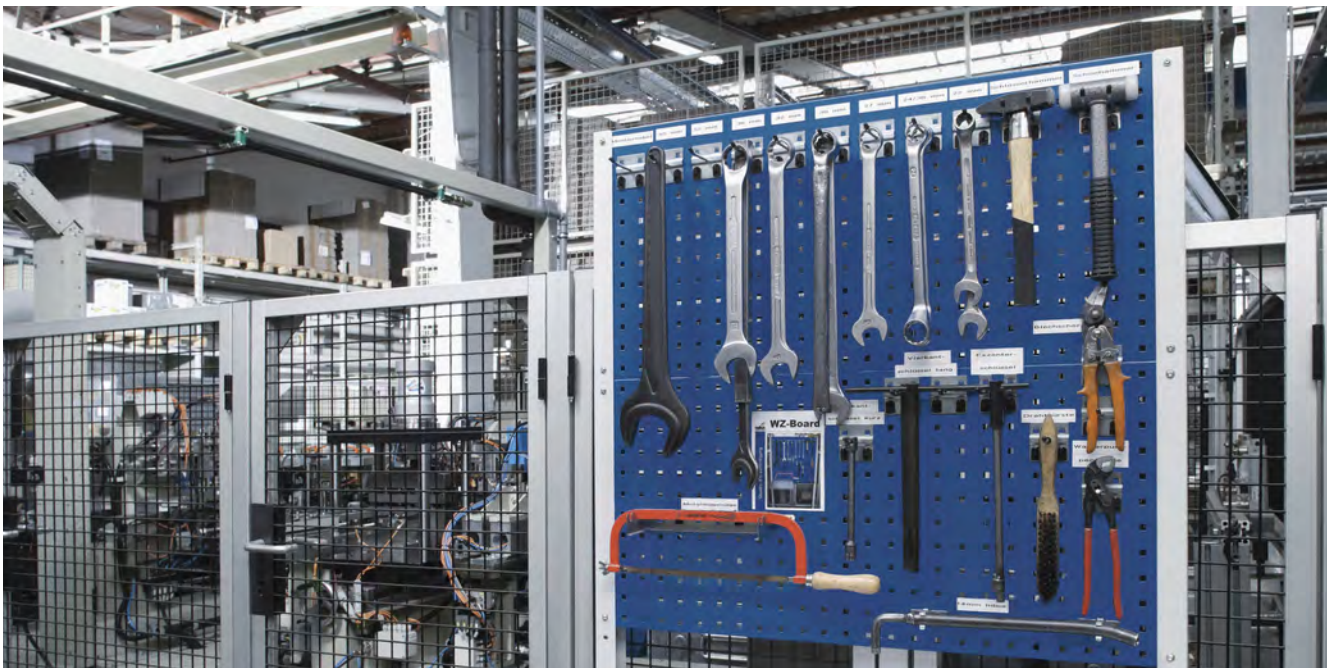

324 Compatible bottBoxes from page 226

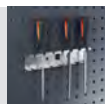

perfo hooks and holders from page 299

Options

mobile with perfo perforated panels and hook kit



- 40 Piece kit
- 10 Hooks
- 10 Double hooks
- 5 U-holder
- 10 Spring clips
- 1 Spanner holder
- 1 Saw holder
- 1 Screwdriver holder
- 1 Allen key holder
- 1 Drill holder
- 4 Swivel & brake castors

Version	With 40 piece hook kit	empty
Dimensions W x D x H [mm]	1000 x 550 x 1250	1000 x 550 x 1250
Weight [kg]	31.00	28.00
Order ref.	16917260.**V	16917160.**V

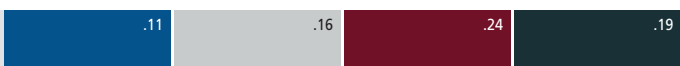

perfo panels: Details on page 15

RAL 5010 – gentian blue RAL 7035 – light grey RAL 3004 – crimson red RAL 7016 – anthracite grey

Rack plus mobile

with perfo louvred panels and bottBoxes



- 2 swivel & brake castors and 2 fixed castors
- 1 pull handle
- 6 perfo louvred panels, can be mounted vertically or at an angle
- Colour of base frame: light grey (RAL 7035)

Version	with bottBoxes	empty
Dimensions W x D x H [mm]	1000 x 650 x 1585	1000 x 650 x 1600
Weight [kg]	103.20	64.60
Order ref.	14026043.16	14026028.19

with perfo louvred panels, bottBoxes and Euroboxes



- 2 swivel & brake castors and 2 fixed castors
- 1 pull handle
- 4 perfo panels, can be mounted vertically or at an angle
- Base shelf as additional storage space suitable for tool cases or Euroboxes
- Colour of base frame: light grey (RAL 7035)

Dimensions W x D x H [mm]	1000 x 650 x 1600
Weight [kg]	86.00
Order ref.	14026044.16

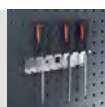

Rack plus mobile

with 6 perfo perforated panels



- 2 swivel & brake castors and 2 fixed castors
- 1 pull handle
- perfo panels, can be mounted vertically or at an angle
- Colour of base frame: light grey (RAL 7035)

Dimensions W x D x H [mm]	1000 x 650 x 1600
Weight [kg]	64.60
Order ref.	14026026.**

with 4 perfo perforated panels



- 2 swivel & brake castors and 2 fixed castors
- 1 pull handle
- perfo panels, can be mounted vertically or at an angle
- Base shelf as additional storage space suitable for tool cases or boxes
- Colour of base frame: light grey (RAL 7035)

Dimensions W x D x H [mm]	1000 x 650 x 1600
Weight [kg]	44.00
Order ref.	14026025.**

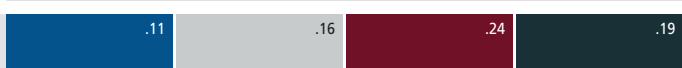

perfo panels: Details on page 15

RAL 5010 – gentian blue RAL 7035 – light grey RAL 3004 – crimson red RAL 7016 – anthracite grey

Accessories for rack plus mobile

Anti-slip mat for base shelf



- Suitable for base shelves of perfo rack plus trolley

Dimensions W x D [mm]	908 x 599
Weight [kg]	5.42
Order ref.	11301169

perfo walls

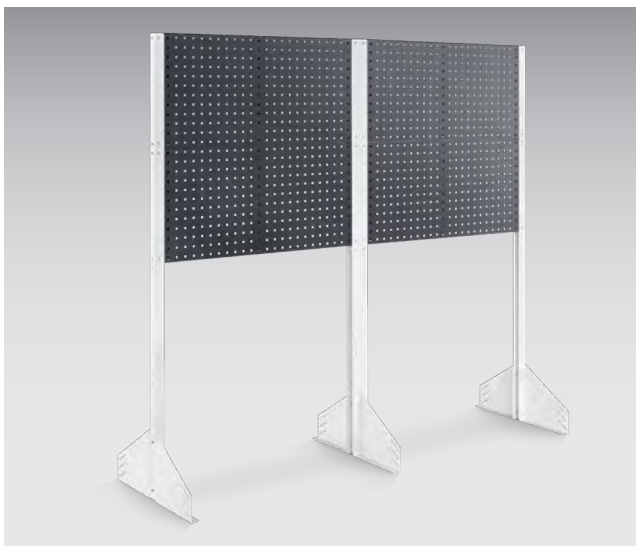

- perfo wall as room dividers or to separate off individual working areas
- Assembly of the walls with max. 8 panels, either perfo perforated panels or perfo louvred panels (max. 4 panels per side) can be used
- Panels installed directly into the perfo wall uprights
- Starter bays and expansion modules are also suitable for 90° angle layouts
- An additional hinged joint is required for variable angle layouts
- Depth at the base: 650 mm
- Colour of the perfo wall uprights: light-grey

Version	perfo wall uprights (1 pair = 2 pieces)
Dimensions W x D x H [mm]	43 x 43 x 1845
Weight [kg]	5.28
Order ref.	08003189.16



328 Compatible bottBoxes from page 226

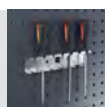

perfo hooks and holders from page 299

perfo Wall

perfo walls with perfo perforation and perfo louvred form



- perfo wall as room dividers or to separate off individual working areas
- Assembly of the walls with max. 8 panels, either perfo perforated panels or perfo louvred panels (max. 4 panels per side) can be used
- Panels installed directly into the perfo wall uprights
- Starter bays and expansion modules are also suitable for 90° angle layouts
- An additional hinged joint is required for variable angle layouts
- Depth at the base: 650 mm
- Colour of the perfo wall uprights: light-grey

Version	perfo wall uprights (1 pair = 2 pieces)	Foot pack (1 pair = 2 pieces)	Hinged joint (1 pair = 2 pieces)	perfo	Horizontal
Dimensions W x D x H [mm]	43 x 43 x 1845	35 x 300 x 275	0 x 0 x 0	990 x 13 x 457	990 x 19 x 457
Weight [kg]	5.28	3.16	0.40	4.07	4.03
Order ref.	08003189.16	08010068.16	88501018	14025117.19	14025139.19

perfo recycling station



- Recycling station for the easy separation of a wide variety of workplace waste
- Label kit includes 7 labels
- Colour: light grey (RAL 7035)

Version	Recycling station
Dimensions W x D x H [mm]	350 x 340 x 990
Weight [kg]	6.36
Order ref.	14030198.16

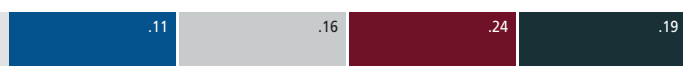

perfo panels: Details on page 15

RAL 5010 – gentian blue RAL 7035 – light grey RAL 3004 – crimson red RAL 7016 – anthracite grey



www.bott-group.com

Bott GmbH & Co. KG, Bahnstraße 17, 74405 Gaildorf, Germany

dialog-aktiv: Telefon: +49 (0)79 71 / 251-251, Telefax: +49 (0)79 71 / 251-205